

# Catálogo 2026

Escadas em Alumínio Soluções Portáteis em Altura



**Catalog | Catálogo | Catalogue**

Aluminum Ladders - Portable Solutions at Height  
Escaleras en Alumínio - Soluciones portátiles en altura  
Échelles en Aluminium - Solutions portables en hauteur

[www.litan.pt](http://www.litan.pt)  
[www.fr.litan.pt](http://www.fr.litan.pt)



# A EMPRESA

LITAN – ESPECIALISTAS NO FABRICO DE ESCADAS EM ALUMÍNIO

A Litan é uma empresa exclusivamente portuguesa que conta com mais de duas décadas de atuação no mercado. Somos especialistas no fabrico de soluções em altura, oferecendo uma variada gama de produtos.

A nossa maior preocupação é garantir a melhor resposta às exigências dos nossos clientes. Este nosso empenho tem-se traduzido no fortalecimento de relações duradouras graças à máxima confiança que os nossos clientes depositam em nós.

Seguimos rigorosos processos de fabrico, com enfoque na inovação constante e em altos padrões de qualidade. Somos extremamente rigorosos em relação à durabilidade do nosso material, pelo que os nossos artigos são fabricados com alumínio de alta qualidade.

A nossa gama divide-se em três tipos de produtos: escadas, escadotes e andaimes. Estes produtos estão adaptados para aplicação em diversos fins, pelo que oferecemos soluções indicadas para trabalhos que vão desde a bricolage ao uso profissional e industrial.

Respeitamos elevados requisitos de segurança durante todo o processo de produção. Este conjunto de cuidados permite-nos oferecer aos nossos clientes a garantia de que adquirem um produto que suprirá as suas necessidades ao mesmo tempo que proporciona o máximo conforto e segurança na utilização.

Os nossos produtos são certificados segundo a norma europeia EN131 e vêm acompanhados com uma garantia de 2 anos.

Na Litan, líder na produção de escadas e escadotes em alumínio, comprometemo-nos com a sustentabilidade e a utilização de energias verdes. Implementamos práticas que minimizam o impacto ambiental, desde a escolha de materiais recicláveis até à otimização dos processos de produção para reduzir o consumo energético. Investimos em fontes de energia renovável, como a instalação de painéis solares nas nossas instalações, contribuindo para a redução da pegada de carbono. Acreditamos que a integração de soluções ecológicas é essencial para o futuro do planeta e para o bem-estar das próximas gerações.



## Translation | Traducción | Traduction

**COMPANY - LITAN - SPECIALISTS IN THE MANUFACTURING OF ALUMINIUM LADDERS** - Litan is an exclusively Portuguese company which has more than two decades in the market. We are specialists in the manufacturing of height solutions, thus offering a wide range of products. Our greatest concern is to guarantee the best answer to our clients' demands. This commitment as allowed us to strengthen long-lasting trustworthy relationships with our clients. We follow strict manufacture processes, focusing on continuous innovation and high quality patterns. We are extremely rigorous in relation to the durability of our material, therefore using only high quality aluminium during the manufacturing of our products. We strive to respect high security requirements during all the production process. This set of concerns allows us to offer our clients the guarantee they are buying a product which will fulfil their needs as well as providing the maximum comfort and security while being used. Our range divides into three types of products: ladders, step ladders and scaffolds. These products are adapted to a variety of purposes. We offer solutions aimed at DIY works as well as to professional and industrial works. Our products are certified according to the EN131 european norm and have a warranty of 2 years.

At Litan, a leader in the production of aluminum ladders and step stools, we are committed to sustainability and the use of green energy. We implement practices that minimize environmental impact, from selecting recyclable materials to optimizing production processes to reduce energy consumption. We invest in renewable energy sources, such as installing solar panels at our facilities, contributing to a lower carbon footprint. We believe that integrating eco-friendly solutions is essential for the future of the planet and the well-being of future generations.

**EMPRESA - LITAN - ESPECIALISTAS EN LA FABRICACIÓN DE ESCALERAS EN ALUMINIO** - Litan es una empresa exclusivamente portuguesa que tiene más de dos décadas de actuación en el mercado. Somos especialistas en la fabricación de soluciones en altura, ofreciendo una gama variada de productos. Nuestra mayor preocupación es la de garantizar la mejor respuesta a las exigencias de nuestros clientes. Este compromiso proporciona el fortalecimiento de relaciones de largo duración y máxima confianza con nuestros clientes. Seguimos rigurosos procesos de fabricación, con enfoque en la innovación constante y altos estándares de calidad. Somos extremadamente rigurosos con respecto a la durabilidad de nuestro material, por lo que nuestros productos son fabricados con aluminio de alta calidad. Respetamos altas exigencias de seguridad durante todo el proceso de producción. Este conjunto de cuidados permite ofrecer a nuestros clientes la garantía de que adquieren un producto que satisface sus necesidades al mismo tiempo que proporciona el máximo confort y seguridad durante la utilización. Nuestra gama está dividida en tres tipos de productos: escaleras, escaleras tijeras y andamios. Estos productos están adaptados para una variedad de propósitos, por lo que ofrecemos soluciones para trabajos desde bricolaje hasta profesionales e industriales. Nuestros productos están certificados según la norma europea EN131 y tienen una garantía de 2 años.

En Litan, líder en la producción de escaleras y taburetes de aluminio, estamos comprometidos con la sostenibilidad y el uso de energías verdes. Implementamos prácticas que minimizan el impacto ambiental, desde la selección de materiales reciclables hasta la optimización de los procesos de producción para reducir el consumo de energía. Invertimos en fuentes de energía renovable, como la instalación de paneles solares en nuestras instalaciones, contribuyendo a la reducción de la huella de carbono. Creemos que la integración de soluciones ecológicas es esencial para el futuro del planeta y el bienestar de las próximas generaciones.

**ENTREPRISE - LITAN - SPÉCIALISTES DANS LA FABRICATION D'ÉCHELLES EN ALUMINIUM** - Litan est une entreprise exclusivement portugaise qui a plus de deux décennies d'actuation dans le marché. Nous sommes spécialistes dans la fabrication de solutions en hauteur, offrant une large gamme de produits. Notre plus grande préoccupation est de garantir la meilleure réponse aux exigences de nos clients. Cet engagement nous a permis de renforcer des relations durables grâce à la confiance de nos clients. Nous suivons des procédés rigoureux de fabrication, avec un accent dans l'innovation constante et dans les hauts niveaux de qualité. Nous sommes extrêmement rigoureux en ce qui concerne la durabilité de notre matériel, donc on n'utilise que d'aluminium d'haute qualité dans la fabrication de nos produits. Nous respectons les normes élevées de sécurité pendant tout le processus de production. Cet ensemble de soins nous permet d'offrir à nos clients la garantie d'acheter un produit qui répondra à toutes ses besoins, au même temps que proportionne le confort maximum et la sécurité pendant l'utilisation. Notre gamme est divisée dans trois types de produits: échelles, escabeaux et échafaudages. Ces produits sont adaptés pour être appliqués dans diverses finalités, donc nous offrons des solutions indiquées pour des travaux dès le bricolage aux travaux professionnels et industriels. Nos produits sont certifiés selon la norme européenne EN131 et ont une garantie de 2 ans.

Chez Litan, leader dans la production d'échelles et d'escabeaux en aluminium, nous nous engageons en faveur du développement durable et de l'utilisation des énergies vertes. Nous mettons en place des pratiques qui minimisent l'impact environnemental, depuis le choix de matériaux recyclables jusqu'à l'optimisation des processus de production afin de réduire la consommation d'énergie. Nous investissons dans des sources d'énergie renouvelable, comme l'installation de panneaux solaires sur nos sites, contribuant ainsi à la réduction de notre empreinte carbone. Nous sommes convaincus que l'intégration de solutions écologiques est essentielle pour l'avenir de la planète et le bien-être des générations futures.

# I&D / Produção / Parcerias / Qualidade / Segurança



## • LITAN ESTANTES METÁLICAS GAMA DE ESCADAS E ESCADOTES

Mais de uma década a fabricar escadas para a indústria, construção e comércio.

Pretendemos, desde a especialização, dinamizar e impulsionar o nosso negócio de alumínio, mantendo como prioridade a qualidade de um nível de serviço superior, melhorando a competitividade. Desenvolvimento, inovação e um grande investimento a nível superior, como demonstra os vários produtos lançados nos mercados, são a reflexo do nosso trabalho na última década.



## • OS VALORES DA LITAN

Queremos corresponder integralmente às necessidades presentes e futuras dos nossos clientes, para tal, é fundamental pautar a nossa atuação por princípios bem definidos.

## • NOSSA VISÃO A CONFIANÇA, PURA E SIMPLES

A confiança em nós depositada, pelos colaboradores e clientes é o nosso bem mais precioso.

A seleção criteriosa dos materiais e a competência na produção, são valores que a LITAN encarna como nenhuma outra empresa. São estes valores que gostamos de discutir com os nossos clientes.



## • A UM NÍVEL SUPERIOR EM QUALIDADE

A LITAN tem como principal preocupação a segurança, estamos continuamente melhorando as diversas famílias de produtos, com um requisito de qualidade que vai muito para além dos padrões existentes.

As modificações de norma EN131 entraram em vigor e impõem aos fabricantes novas regras, foram adicionados novos testes e cada produto terá que passar sistematicamente esse controle de forma a garantirem produtos mais seguros e com mais conforto.



A LITAN aproveitou este impacto para qualificar a sua gama com testes mais extensivos e exigentes, acompanhando principalmente a modificações em todos os produtos com mais de 3 metros, com destaque para os modelos de escadas triplas, que a partir de agora são indissociáveis.

As sinalizações também evoluem, com novas instruções e marcações de segurança mais explícitas que enriquecerão as já existentes, inclusive na forma de pictogramas, são mais homogêneos e compreensíveis para todos.



## • Norma EN131.....NOVOS DESAFIOS

O desenvolvimento é um desafio e esta faz parte do nosso ADN, os nossos produtos garantem sempre a resistência e estabilidade que o mercado exige, e este resultado é otimizado em todos os produtos da LITAN.

## • QUALIDADE E SERVIÇO

O profissionalismo e a satisfação dos nossos clientes são a nossa meta diária. Temos uma equipa coesa, experiente e orientada para os desafios, qualificada para desenvolver novas soluções ao encontro das necessidades dos nossos clientes.

Atingir um nível de qualidade elevado tornou-se uma preocupação central. O nosso serviço pós-venda e a qualidade dos nossos produtos são o sucesso e garantia da nossa imagem de marca.

Confiança, qualidade e excelência em cada negócio.



## • COMPETINDO PELO FUTURO

A Litan continua a ampliar o seu mercado em vários países da Europa, África América do Sul e Ásia, a nossa grande aposta é promover os produtos e a marca Litan.

Temos presença nos seguintes países: Espanha / França / Luxemburgo / Suíça / Marrocos/ Tunísia / Argélia / Líbia/ Egípto/ Gana / Guiné/ Costa do Marfim/ Angola/ Moçambique / Namíbia/ Nigéria / Brasil/ Chile.



Fabrico, Desenvolvimento e produção 100% português

MADE IN

ALITAN está onde estão os seus clientes.

Translation | Traducción | Traduction

 R&D / Production / Partnerships / Quality / Safety • 100% Portuguese Manufacturing, Development and Production

 I + D / Producción / Asociaciones / Calidad / Seguridad • Fabricación, desarrollo y producción 100% portugueses

 R&D / Production / Partenariats / Qualité / Sécurité • Fabrication, développement et production 100% portugais

# O NOSSO COMPROMISSO



Inovação



Stock Disponível



Compromisso e Empreendedorismo



Relação Qualidade/Preço



Soluções à sua medida



Apoio ao Cliente



Exportação

**EN** LITAN METALLIC SHELVES RANGE OF LADDERS AND STEPLADDERS - Decades of manufacturing ladders for industry, construction and commerce. From specialization, we intend to streamline and boost our aluminum business, maintaining as a priority the quality of a superior service level, improving competitiveness. Development, innovation and a large investment at a higher level, as demonstrated by the various products launched on the markets, are a reflection of our work over the last decade - LITAN'S VALUES - We want to fully respond to the present and future needs of our customers, therefore, it is essential to guide our performance by well-defined principles. - OUR VISION TRUST, PURE AND SIMPLE - The trust placed in us by employees and customers is our most precious asset. The careful selection of materials and competence in production are values that LITAN embodies like no other company. It is these values that we like to discuss with our customers. - AT A SUPERIOR LEVEL OF QUALITY. LITAN's main concern is safety, we are continuously improving the various product families, with a quality requirement that goes far beyond existing standards. The EN131 standard changes came into effect and impose new rules on manufacturers, new tests have been added and each product will have to systematically pass this control in order to ensure safer and more comfortable products. LITAN took advantage of this impact to qualify its range with more extensive and demanding tests, mainly following changes in all products over 3 meters, with emphasis on the triple ladder models, which from now on are inseparable. The signs are also evolving, with new instructions and more explicit safety markings that will enrich the existing ones, including in the form of pictograms, they are more homogeneous and understandable for everyone. Standard EN131 NEW CHALLENGES - Development is a challenge and this is part of our DNA, our products always guarantee the strength and stability that the market demands, and this result is optimized in all LITAN products. QUALITY AND SERVICE The professionalism and satisfaction of our customers is our daily goal. We have a cohesive, experienced and challenge-oriented team, qualified to develop new solutions to meet the needs of our customers. Achieving a high level of quality has become a central concern. Our after-sales service and the quality of our products are the success and guarantee of our brand image. Trust, quality and excellence in every business. COMPETING FOR THE FUTURE LITAN continues to expand its market in several countries in Europe, Africa, South America and Asia, our big bet is to promote Litan's products and brand. We are present in the following countries: Spain / France / Luxembourg / Switzerland / Morocco / Tunisia / Algeria / Libya / Egypt / Ghana / Guinea / Ivory Coast / Angola / Mozambique / Namibia / Nigeria / Brazil / Chile. LITAN is where its customers are.

**EN** ESTANTES METÁLICAS LITANOS GAMA DE ESCALERAS Y ESCALERASTIJERAS - Décadas de fabricación de escaleras para la industria, la construcción y el comercio. Desde la especialización, pretendemos agilizar e impulsar nuestro negocio de aluminio, manteniendo como prioridad la calidad de un nivel de servicio superior, mejorando la competitividad. El desarrollo, la innovación y una gran inversión a un nivel superior, como lo demuestran los distintos productos lanzados a los mercados, son reflejo de nuestro trabajo durante la última década. LOS VALORES DE LITAN - Queremos dar respuesta integral a las necesidades presentes y futuras de nuestros clientes, por ello, es fundamental orientar nuestro desempeño por principios bien definidos. - NUESTRA VISIÓN CONFIANZA, PURA Y SENCILLA - La confianza depositada en nosotros por empleados y clientes es nuestro activo más preciado. La cuidadosa selección de materiales y la competencia en la producción son valores que LITAN encarna como ninguna otra empresa. Son estos valores los que nos gusta discutir con nuestros clientes. - AUN NIVEL SUPERIOR DE CALIDAD. La principal preocupación de LITAN es la seguridad, estamos mejorando continuamente las distintas familias de productos, con un requisito de calidad que va mucho más allá de los estándares existentes. Los cambios de la norma EN131 entrarán en vigencia e imponen nuevas reglas a los fabricantes, se han agregado nuevas pruebas y cada producto deberá pasar sistemáticamente este control para garantizar productos más seguros y cómodos. LITAN aprovechó este impacto para calificar su gama con pruebas más extensas y exigentes, principalmente siguiendo cambios en todos los productos a más de 3 metros, con énfasis en los modelos de triple escalera, que a partir de ahora son inseparables. Las señales también están evolucionando, con nuevas instrucciones y marcas de seguridad más explícitas que enriquecerán las existentes, incluso en forma de pictogramas, son más homogéneas y comprensibles para todos. Norma EN131 - NUEVOS DESAFÍOS - El desarrollo es un desafío y esto es parte de nuestro ADN, nuestros productos garantizan siempre la solidez y estabilidad que demanda el mercado, este resultado se optimiza en todos los productos LITAN. - CALIDAD Y SERVICIO - La profesionalidad y satisfacción de nuestros clientes es nuestro objetivo diario. Contamos con un equipo cohesionado, experimentado y orientado a los retos, capacitado para desarrollar nuevas soluciones que satisfagan las necesidades de nuestros clientes. Lograr un alto nivel de calidad se ha convertido en una preocupación central. Nuestro servicio postventa y la calidad de nuestros productos son el éxito y garantía de nuestra imagen de marca. Confianza, calidad y excelencia en cada negocio. COMPITIENDO POR EL FUTURO - LITAN continúa expandiendo su mercado en varios países de Europa, África, Sudamérica y Asia, nuestra gran apuesta es promover los productos y la marca Litan. Estamos presentes en los siguientes países: España / Francia / Luxemburgo / Suiza / Marruecos / Túnez / Argelia / Libia / Egipto / Ghana / Guinea / Costa de Marfil / Angola / Mozambique / Namibia / Nigeria / Brasil / Chile. LITAN está donde están sus clientes.

**EN** ÉTAGERES MÉTALLIQUES LITAN GAMME D'ÉCHELLES ET ESCABEAUX - Des décennies de fabrication d'échelles pour l'industrie, la construction et le commerce. De la spécialisation, nous entendons rationaliser et dynamiser notre activité aluminium, en maintenant comme priorité la qualité d'un niveau de service supérieur, en améliorant la compétitivité. Le développement, l'innovation et un investissement important à un niveau supérieur, comme en témoignent les différents produits lancés sur les marchés, sont le reflet de notre travail au cours de la dernière décennie. LES VALEURS DE LITAN - Nous voulons répondre pleinement aux besoins présents et futurs de nos clients, il est donc essentiel de guider notre performance par des principes bien définis. NOTRE VISION CONFIANCE, PURE ET SIMPLE - La confiance que nous accordent nos collaborateurs et nos clients est notre bien le plus précieux. La sélection rigoureuse des matériaux et la compétence dans la production sont des valeurs que LITAN incarne comme aucune autre entreprise. Ce sont ces valeurs que nous aimons discuter avec nos clients. À UN NIVEAU DE QUALITÉ SUPÉRIEURE. La principale préoccupation de LITAN est la sécurité, nous améliorons en permanence les différentes familles de produits, avec une exigence de qualité qui va bien au-delà des normes existantes. Les évolutions de la norme EN131 sont entrées en vigueur et imposent de nouvelles règles aux fabricants, de nouveaux tests ont été ajoutés et chaque produit devra systématiquement passer ce contrôle afin de garantir des produits plus sûrs et plus confortables. Le LITAN a profité de cet impact pour qualifier sa gamme de tests plus poussés et exigeants, principalement suite à des évolutions de tous les produits au-delà de 3 mètres, en mettant l'accent sur les modèles à triple échelle, désormais indissociables. La signalétique évolue également, avec de nouvelles consignes et des marquages de sécurité plus explicites qui viendront enrichir l'existant, y compris sous forme de pictogrammes, ils sont plus homogènes et compréhensibles pour tous. - Norme EN131 - NOUVEAUX DÉFIS - Le développement est un défi et cela fait partie de notre ADN, nos produits garantissent toujours la résistance et la stabilité exigées par le marché, et ce résultat est optimisé dans tous les produits LITAN. - QUALITÉ ET SERVICE - Le professionnalisme et la satisfaction de nos clients est notre objectif quotidien. Nous avons une équipe soudée, expérimentée et axée sur les défis, qualifiée pour développer de nouvelles solutions pour répondre aux besoins de nos clients. Atteindre un haut niveau de qualité est devenu une préoccupation centrale. Notre service après-vente et la qualité de nos produits sont le succès et la garantie de notre image de marque. Confiance, qualité et excellence dans chaque entreprise. CONCURRENCE POUR L'AVENIR - LITAN continue d'étendre son marché dans plusieurs pays d'Europe, d'Afrique, d'Amérique du Sud et d'Asie, notre grand pari est de promouvoir les produits et la marque Litan. Nous sommes présents dans les pays suivants : Espagne / France / Luxembourg / Suisse / Maroc / Tunisie / Algérie / Libye / Égypte / Ghana / Guinée / Côte d'Ivoire / Angola / Mozambique / Namibie / Nigeria / Brésil / Chili. LITAN est là où sont ses clients.



# INFORMAÇÃO DO PRODUTO

- Em cada um dos produtos, está colada uma etiqueta adesiva com as seguintes descrições:
- Certificado de conformidade do produto e as normas de qualidade
  - Certificado de segurança do produto
  - Informa o cliente dos diferentes tipos de utilização da cada modelo
  - Indica, em cada modelo, o nome, a capacidade, as alturas, os pesos e o número de degraus.

**ESCADA DE ALUMÍNIO**  
Escalera Aluminio  
Aluminium Ladder  
Échelle en Aluminium

**MULTIUSOS**



4x3	1,58	3,21	2,40
4x4	2,04	4,20	3,20
4x5	2,53	5,25	3,94

















Medidas e pesos aproximados

**ANO E MÊS DE FABRICO**  
AÑO Y MES DE FABRICACIÓN  
ANO/AÑO/ YEAR/ANNÉE

23	24	25	26
----	----	----	----

LOTE N° / LOT N°

 max. 150 kg	 max. 1
 min. 1,1m	 65-75°
 min. 1,1m	 UP
 max.	 max.
 max.	 max.
 max.	 max.
 max.	 max.
 max.	 max.
 max.	 max.

**MADE IN UE**  
Conforme Normas de Segurança  
Conforme Las Normas de Seguridad  
Conforme Aux Exigences de Sécurité  
**EN 131**

## Dimensões

Dimensions / Dimensiones / Dimensions

## Informações

### sobre a fabricação

Information about manufacturing  
Información sobre la fabricación  
Informations sur la fabrication

## Pictogramas informativos de fácil compreensão

informational pictograms easy to understand  
pictogramas informativos fácil de entender  
pictogrammes informatifs facile à comprendre

## Certificação

Certification  
Certificación  
Certification

Escalera Aluminio  
Escalera Aluminio  
Escalera Aluminio



**MADE IN UE**  
Conforme Normas de Segurança  
Conforme Las Normas de Seguridad  
Conforme Aux Exigences de Sécurité  
**EN 131**

**ESCADA DE ALUMÍNIO**  
Escalera Aluminio  
Aluminium Ladder  
Échelle en Aluminium

**MULTIPOSICIONES**

4x3	1,58	2,79	2,40
4x4	1,80	3,79	3,20
4x5	2,28	4,79	3,20
4x6	2,76	5,79	3,94

ANO E MÊS DE FABRICO  
AÑO Y MES DE FABRICACIÓN  
ANO/AÑO/ YEAR/ANNÉE

23	24	25	26
----	----	----	----

LOTE N° / LOT N°



**MADE IN UE**  
Conforme Normas de Segurança  
Conforme Las Normas de Seguridad  
Conforme Aux Exigences de Sécurité  
**EN 131**

**ESCADOTE ALUMÍNIO**  
Escalera Aluminio  
Aluminium Ladder  
Échelle en Aluminium

**POTENTE**

23	2,11	3,36	3,2
24	2,38	4,61	3,2
25	2,66	5,86	3,2
26	2,93	7,11	3,2
27	3,21	8,36	3,2
28	3,48	9,61	3,2
29	3,76	10,86	3,2
30	4,03	12,11	3,2

ANO E MÊS DE FABRICO  
AÑO Y MES DE FABRICACIÓN  
ANO/AÑO/ YEAR/ANNÉE

23	24	25	26
----	----	----	----

LOTE N° / LOT N°



**MADE IN UE**  
Conforme Normas de Segurança  
Conforme Las Normas de Seguridad  
Conforme Aux Exigences de Sécurité  
**EN 131**

**ESCADOTE ALUMÍNIO**  
Escalera Aluminio  
Aluminium Ladder  
Échelle en Aluminium

**TABURETE**

23	1,80	3,05	2,40
24	1,80	3,05	2,40

ANO E MÊS DE FABRICO  
AÑO Y MES DE FABRICACIÓN  
ANO/AÑO/ YEAR/ANNÉE

23	24	25	26
----	----	----	----

LOTE N° / LOT N°



**MADE IN UE**  
Conforme Normas de Segurança  
Conforme Las Normas de Seguridad  
Conforme Aux Exigences de Sécurité  
**EN 131**

**ESCADA DI ALUMÍNIO**  
Escalera Aluminio  
Aluminium Ladder  
Échelle en Aluminium



**L66 2x**

















23	2,28	3,53	3,2
24	2,56	4,78	3,2
25	2,84	6,03	3,2
26	3,12	7,28	3,2
27	3,40	8,53	3,2
28	3,68	9,78	3,2
29	3,96	11,03	3,2
30	4,24	12,28	3,2

ANO E MÊS DE FABRICO  
AÑO Y MES DE FABRICACIÓN  
ANO/AÑO/ YEAR/ANNÉE

23	24	25	26
----	----	----	----

LOTE N° / LOT N°

**MADE IN UE**  
Conforme Normas de Segurança  
Conforme Las Normas de Seguridad  
Conforme Aux Exigences de Sécurité  
**EN-131**

**ESCADA DI ALUMÍNIO**  
Escalera Aluminio  
Aluminium Ladder  
Échelle en Aluminium

**LPROFI 3x**

23	2,56	3,81	3,2
24	2,84	5,06	3,2
25	3,12	6,31	3,2
26	3,40	7,56	3,2
27	3,68	8,81	3,2
28	3,96	10,06	3,2
29	4,24	11,31	3,2
30	4,52	12,56	3,2

ANO E MÊS DE FABRICO  
AÑO Y MES DE FABRICACIÓN  
ANO/AÑO/ YEAR/ANNÉE

23	24	25	26
----	----	----	----

LOTE N° / LOT N°



**MADE IN UE**  
Conforme Normas de Segurança  
Conforme Las Normas de Seguridad  
Conforme Aux Exigences de Sécurité  
**EN 131**

## Translation | Traducción | Traduction

Product Information - An adhesive label with the following descriptions is attached to each product: Certificate of product conformity and quality standards - Product safety certificate - Information of the different types of use of each model - Indicates, on each model, the name, capacity, heights, weights and number of steps.

Información del Producto - A cada uno de los productos se adjunta una etiqueta adhesiva con las siguientes descripciones: Certificado de conformidad del producto y estándares de calidad - Certificado de seguridad del producto - Informa al cliente de los diferentes tipos de uso de cada modelo - Indica, en cada modelo, el nombre, capacidad, alturas, pesos y número de escalones.

Information du Produit - Une étiquette adhésive avec les descriptions suivantes est apposée sur chacun des produits : Certificat de conformité des produits et normes de qualité - Certificat de sécurité du produit - Informe le client des différents types d'utilisation de chaque modèle - Indique, sur chaque modèle, le nom, la capacité, les hauteurs, les poids et le nombre de marches.

# ÍNDICE

Index / Índice / Index

# 1

## Gama Escadas em Alumínio

Aluminium Stairs | Escaleras de aluminio | Échelles en Aluminium

P. 09 | 21



# 2

## Gama Escadas Multifunções

Multifunction Stairs | Escaleras multifunción | Échelles multifonctionnels

P. 22 | 27



# 3

## Gama Escadotes em Alumínio

Aluminium Stepladders | Escaleras Tijeras | Escabeaux en Aluminium

P. 29 | 44



# 4

## Andaimes

Scaffolds | Andamios | Échafaudages

P. 45 | 55



# 5

## Diversos

Miscellaneous | Varios | Divers

P. 56 | 58





# ESCADA LINHA STANDARD L66 EM ALUMÍNIO

STANDARD LINE L66 ALUMINIUM LADDER | ESCALERA DE ALUMINIO STANDARD LINE L66 | ÉCHELLE EN ALUMINIUM STANDARD LINE L66

## Características

Modelo clássico, bastante resistente e fácil de transportar. A escada Standard L66 permite a utilização em espaços mais estreitos. Permite uma grande estabilidade, robustez e segurança de trabalho. Aconselha-se uma verificação antes de cada utilização. Disponível na versão de 2 a 6 metros.

- Construída em tubo de alumínio 65mmx25mm
- Degraus em tubo 28x28mm com relevos antiderrapantes
- Distância de 250mm entre degraus
- Degraus firmemente embutidos às secções laterais
- Base Estabilizadora com pés de borracha antiderrapantes a partir de 3 metros
- Tacos de plástico nos topos dos perfis
- Grau de inclinação em utilização – 65° a 75°

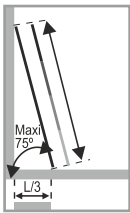
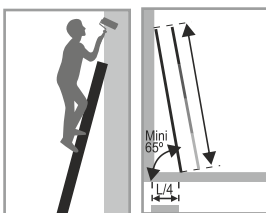

Degrau  
28x28 mm

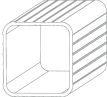

Perfil  
65x25 mm

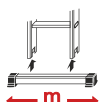
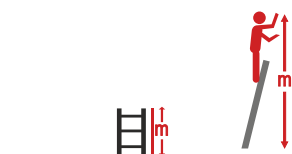
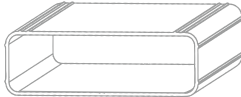

Altura (m)	Comprimento (m)	Distância entre degraus (mm)	Distância entre perfis (mm)	Distância entre perfis (mm)	Distância entre perfis (mm)	Peso (KG)	Volume (m³)	Ref
* 2,00	2,99	7	0,405	-	66x25	3,20	0,270	A10010020
* 2,50	3,49	9	0,405	-	66x25	4,10	0,337	A10010025
* 3,00	3,99	11	0,405	0,950	66x25	5,10	0,405	A10010030
* 3,50	4,49	13	0,405	0,950	66x25	6,20	0,472	A10010035
* 4,00	4,99	15	0,405	0,950	66x25	7,10	0,540	A10010040
5,00	5,99	19	0,405	0,950	66x25	8,20	0,750	A10010050
6,00	6,99	23	0,405	1,200	66x25	10,40	0,900	A10010060

## Translation | Traducción | Traduction

Aluminum Ladders Standard Line L66 - Simple Ladder - Classic model, very resistant and easy to transport. The Standard L66 ladder allows for use in narrower spaces. It allows for great stability, strength and work safety. It is advisable to check it before each use, available in version from 2 to 6 meters. Built in 65mmx25mm aluminum tube, 28x28mm tube steps with non-slip reliefs, 250mm distance between steps, steps firmly embedded in side sections, stabilizer base with non-slip rubber feet from 3 meters, plastic plugs on the tops of the profiles, degree of inclination in use - 65° to 75°.

Escaleras Línea Standard L66 en Aluminio - Escalera Simple - Modelo clásico, muy resistente y fácil de transportar. La escalera Standard L66 permite su uso en espacios reducidos, lo que permite una gran estabilidad, resistencia y seguridad en el trabajo. Es recomendable comprobarlo antes de cada uso. Disponible en versión de 2 a 6 metros, construido en tubo de aluminio de 65 mm x 25 mm, escalones de tubo de 28x28 mm con relieves antideslizantes, 250 mm de distancia entre escalones, pasos firmemente incrustados en las secciones laterales, base estabilizadora con pies de goma antideslizantes a partir de 3 metros, tapones de plástico en la parte superior de los perfiles, grado de inclinación en uso - 65° a 75°.

Échelles Ligne Standard L66 en Aluminium - Échelle Simple - Modèle classique, très résistant et facile à transporter. L'échelle Standard L66 permet une utilisation dans des espaces plus restreints. Elle permet une grande stabilité, résistance et sécurité de travail. Il est conseillé de vérifier avant chaque utilisation, disponible en version de 2 à 6 mètres, construit en tube d'aluminium de 65 mm x 25 mm, marches en tube de 28x28 mm avec reliefs antidérapants, distance de 250 mm entre les marches, marches solidement encastrées dans les sections latérales, base stabilisatrice avec pieds en caoutchouc antidérapants à partir de 3 mètres, bouchons en plastique sur les sommets des profils, degré d'inclinaison en cours d'utilisation - 65° à 75°.



# ESCADA DUPLA LINHA STANDARD L66 EM ALUMÍNIO

STANDARD LINE L66 ALUMINIUM DOUBLE LADDER | LÍNEA ESTÁNDAR L66 ESCALERA DOBLE DE ALUMINIO | STANDARD LINE L66 ALUMINIUM DOUBLE ÉCHELLE

## Características

Modelo clássico, bastante resistente e fácil de transportar. Permite uma elevada estabilidade e segurança de trabalho.

Fácil de montar e utilizar, robusta e facilmente adaptável.

Aconselha-se uma verificação antes de cada utilização.

- Composta por 2 lances
- Transformável em 2 versões, escada extensível ou escadote
- Construída em tubo de alumínio 65mmx25mm
- Degraus em tubo 28x28mm com relevos antiderrapantes
- Distância de 250mm entre degraus
- Degraus firmemente embutidos às secções laterais
- Base Estabilizadora com pés de borracha antiderrapantes
- Tacos de plástico nos topos dos perfis
- Grau de inclinação em utilização – 65° a 75°
- Sistema de bloqueio de segurança e encaixe rápido
- Precintas de segurança antiabertura excessiva
- Sistema de deslizamento em alumínio colocados nas laterais
- Casquilho de segurança e limitador de extensão

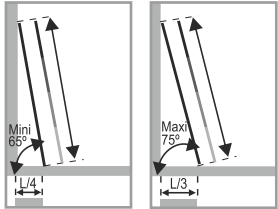
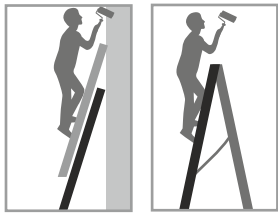

Opção Rodas Superiores

Degrau 28x28 mm

Perfil 65x25 mm

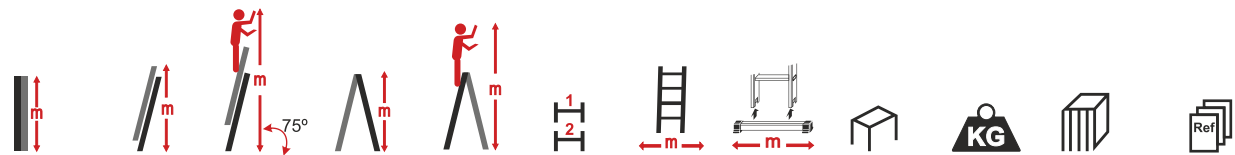
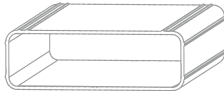

2,00+2,00	3,25	4,24	2,00	2,99	* 2x7	0,470	0,950	66x25	8,30	0,560	A10011020
2,50+2,50	4,25	5,24	2,45	3,44	* 2x9	0,470	0,950	66x25	10,00	0,700	A10011025
3,00+3,00	5,25	6,24	2,95	3,94	* 2x11	0,470	0,950	66x25	12,20	0,840	A10011030
3,50+3,50	6,25	7,24	3,45	4,44	* 2x13	0,470	0,950	66x25	13,10	0,980	A10011035
4,00+4,00	7,25	8,24	3,90	4,89	* 2x15	0,470	1,100	66x25	15,20	1,120	A10011040
5,00+5,00	9,25	10,24	4,90	5,89	2x19	0,470	1,200	66x25	18,10	1,400	A10011050
6,00+6,00	11,25	12,24	5,80	6,79	2x23	0,470	1,200	66x25	21,50	1,680	A10011060

## Translation | Traducción | Traduction

**Aluminum Ladders Standard Line L66 - Double Ladder - Classic model, very resistant and easy to transport. Provides high stability and work safety. Easy to assemble and use, robust and easily adaptable. It is advisable to check it before each use. Consisting of 2 sections. Convertible into 2 versions, extendable ladder or ladder. Built in 65mmx25mm aluminum tube. 28x28mm tube steps with non-slip reliefs. 250mm distance between steps. Steps firmly embedded in side sections. Stabilizer base with non-slip rubber feet. Plastic plugs on the tops of the profiles. Degree of inclination in use - 65° to 75°. Safety locking system and quick fitting. Excessive anti-opening safety straps. Aluminum sliding system placed on the sides. Safety bushing and extension limiter.**

**Escaleras Línea Standard L66 en Aluminio - Escalera Doble - Modelo clásico, muy resistente y fácil de transportar. Proporciona una gran estabilidad y seguridad en el trabajo. Fácil de montar y utilizar, robusto y fácilmente adaptable. Es recomendable comprobarlo antes de cada uso. Consta de 2 secciones. Convertible en 2 versiones, escalera extensible o escalera. Construido en tubo de aluminio de 65 mm x 25 mm. Escalones de tubo de 28x28 mm con relieves antiderrapantes. 250 mm de distancia entre escalones. Pasos firmemente incrustados en las secciones laterales. Base estabilizadora con pies de goma antiderrapantes. Tapones de plástico en la parte superior de los perfiles. Grado de inclinación en uso - 65° a 75°. Sistema de bloqueo de seguridad y montaje rápido. Correas de seguridad antiapertura excesivas. Sistema de deslizamiento de aluminio colocado en los laterales. Casquillo de seguridad y limitador de extensión.**

**Échelles Ligne Standard L66 en Aluminium - Echelle Double - Modèle classique, très résistant et facile à transporter. Fournit une stabilité et une sécurité de travail élevées. Facile à assembler et à utiliser, robuste et facilement adaptable. Il est conseillé de vérifier avant chaque utilisation. Composée de 2 sections. Convertible en 2 versions, échelle extensible ou échelle. Construit en tube d'aluminium de 65 mm x 25 mm. Marches en tube de 28 x 28 mm avec reliefs antidérapants. Distance de 250 mm entre les marches. Marches solidement encastrées dans les sections latérales. Base stabilisatrice avec pieds en caoutchouc antidérapants. Bouchons en plastique sur les sommets des profilés. Degré d'inclinaison en cours d'utilisation - 65° à 75°. Système de verrouillage de sécurité et montage rapide. Sangles de sécurité anti-ouverture excessives. Système coulissant en aluminium placé sur les côtés. Douille de sécurité et limiteur d'extension.**



# ESCADA DUPLA C/CORDA LINHA STANDARD L66 EM ALUMÍNIO

DOUBLE LADDER WITH ROPE STANDARD LINE L66 IN ALUMINIUM | ESCALERA DOBLE CON CUERDA LÍNEA ESTÁNDAR L66 EN ALUMINIO |  
ECELLE DOUBLE A CORDE STANDARD LINE L66 EN ALUMINIUM

## Características

Modelo clássico, robusto, bastante resistente e fácil de transportar.  
O sistema da corda facilita a extensão da escada e bloqueia a escada na altura pretendida, impedindo que a secção superior deslize.  
Aconselha-se uma verificação antes de cada utilização.  
Disponível na versão de 2 a 6 metros.

- Composta por 2 lances
- Construída em tubo de alumínio 65mmx25mm
- Degraus em tubo 28x28mm antiderrapantes
- Distância de 250mm entre degraus
- Degraus firmemente embutidos às secções laterais
- Base Estabilizadora com pés de borracha antiderrapantes
- Sistema de bloqueio de segurança e encaixe rápido
- Precintas de segurança anti abertura excessiva
- Sistema de deslizamento em alumínio colocados as laterais
- Casquilho de segurança e limitador de extensão
- Tacos de plástico nos topos dos perfis
- Grau de inclinação em utilização – 65° a 75°

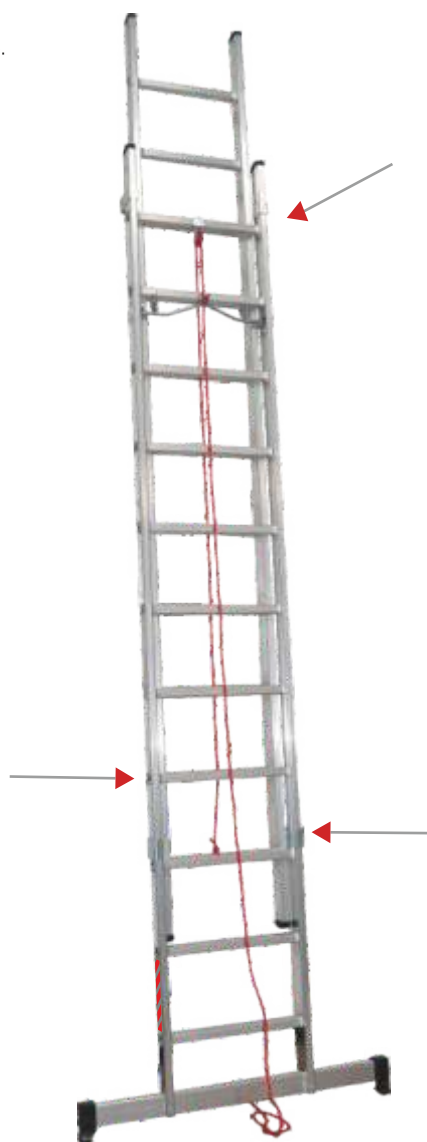
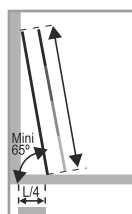
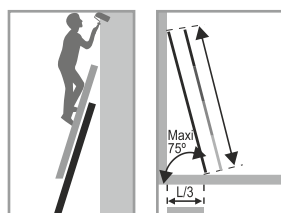

Degrau  
28x28 mm

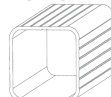

Perfil  
65x25 mm

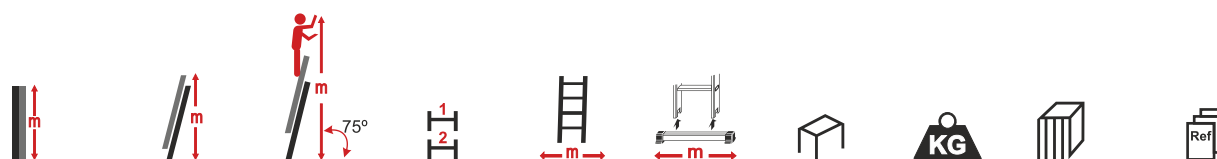

2,00+2,00	3,25	4,24	*2x7	0,470	0,950	66x25	9,10	0,560	A10012020
2,50+2,50	4,25	5,24	*2x9	0,470	0,950	66x25	11,10	0,700	A10012025
3,00+3,00	5,25	6,24	*2x11	0,470	0,950	66x25	12,20	0,840	A10012030
3,50+3,50	6,25	7,24	*2x13	0,470	0,950	66x25	14,20	0,980	A10012035
4,00+4,00	7,25	8,24	*2x15	0,470	1,100	66x25	16,20	1,120	A10012040
5,00+5,00	9,25	10,24	2x19	0,470	1,200	66x25	19,00	1,400	A10012050
6,00+6,00	11,25	12,24	2x23	0,470	1,200	66x25	23,30	1,680	A10012060

## Translation | Traducción | Traduction

Aluminum Ladders Standard Line L66 - Double Ladder w/ Rope - Classic model, robust, very resistant and easy to transport. Rope system facilitates ladder extension and locks the ladder at the desired height, preventing the upper section from sliding. Checking is advised before each use. Available in version from 2 to 6 meters. Consisting of 2 sections - Built in 65mmx25mm aluminum tube - 28x28mm non-slip tube steps - 250mm distance between steps - Steps firmly embedded in side sections - Stabilizer base with non-slip rubber feet - Safety locking system and quick-fitting - Anti-over-opening safety straps - Aluminum sliding system placed on the sides - Safety bushing and extension limiter - Plastic plugs on the tops of the profiles - Degree of inclination in use - 65° to 75°.

Escaleras Línea Standard L66 en Aluminio - Escalera Doble c/ Cuerda - Modelo clásico, robusto, muy resistente y fácil de transportar. El sistema de cuerda facilita la extensión de la escalera y bloquea la escalera a la altura deseada, evitando que la sección superior se deslice. Se recomienda realizar una comprobación antes de cada uso. Disponible en versión de 2 a 6 metros. Consta de 2 secciones - Construido en tubo de aluminio de 65 mm x 25 mm - Escalones de tubo antiderrapantes de 28 x 28 mm - Distancia de 250 mm entre los escalones - Pasos firmemente incrustados en las secciones laterales - Base estabilizadora con pies de goma antiderrapantes - Sistema de bloqueo de seguridad y montaje rápido - Correa de seguridad anti-sobreapertura - Sistema de deslizamiento de aluminio colocado en los laterales - Casquillo de seguridad y limitador de extensión - Tapones de plástico en la parte superior de los perfiles - Grado de inclinación en uso - 65° a 75°.

Échelles Ligne Standard L66 en Aluminium - Échelle Double avec Corde - Modèle classique, robuste, très résistant et facile à transporter. Le système de corde facilite l'extension de l'échelle et verrouille l'échelle à la hauteur souhaitée, empêchant la partie supérieure de glisser. Un contrôle est conseillé avant chaque utilisation. - Disponible en version de 2 à 6 mètres. - Composé de 2 sections - Construit en tube d'aluminium de 65 mm x 25 mm - Marches de tube antiderrapantes de 28 x 28 mm - Distance de 250 mm entre les marches - Marches solidement encastrées dans les sections latérales - Base stabilisatrice avec pieds en caoutchouc antiderrapants - Système de verrouillage de sécurité et montage rapide - Sangles de sécurité anti-ouverture - Système coulissant en aluminium placé sur les côtés - Douille de sécurité et limiteur d'extension - Bouchons en plastique sur les sommets des profiles - Degré d'inclinaison en cours d'utilisation - 65° à 75°.



# ESCADA TRIPLA LINHA STANDARD L66 EM ALUMÍNIO

STANDARD LINE L66 ALUMINIUM TRIPLE LADDER | LÍNEA ESTÁNDAR L66 ESCALERA TRIPLE DE ALUMINIO | STANDARD LINE L66 ALUMINIUM TRIPLE ÉCHELLE

## Características

Modelo clássico, robusta, bastante resistente e fácil de transportar.

A escada obriga a vários requisitos de segurança durante a sua utilização

É um modelo que permite o acesso a alturas muito elevadas, é fundamental obter a estabilidade necessária na sua utilização. Aconselha-se uma verificação antes de cada utilização.

Disponível na versão de 2 a 4 metros.

- Composta por 3 lances
- Transformável em 2 versões, escada extensível ou escadote
- Construída em tubo de alumínio 65mmx25mm
- Degraus em tubo 28x28mm antiderrapantes
- Distância de 250mm entre degraus
- Degraus firmemente embutidos às secções laterais
- Base Estabilizadora com pés de borracha antiderrapantes
- Tapos de plástico nos topos dos perfis
- Grau de inclinação em utilização – 65° a 75°
- Sistema de bloqueio de segurança e encaixe rápido
- Precintas de segurança antiabertura excessiva
- Sistema de deslizamento em alumínio colocados as laterais
- Casquilho de segurança e limitador de extensão

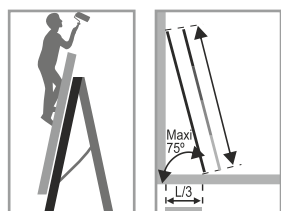
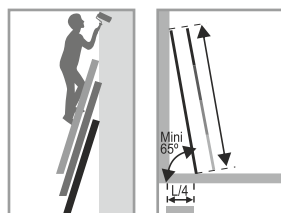

Opção Rodas Superiores

Degrau 28x28 mm

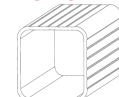

Perfil 65x25 mm

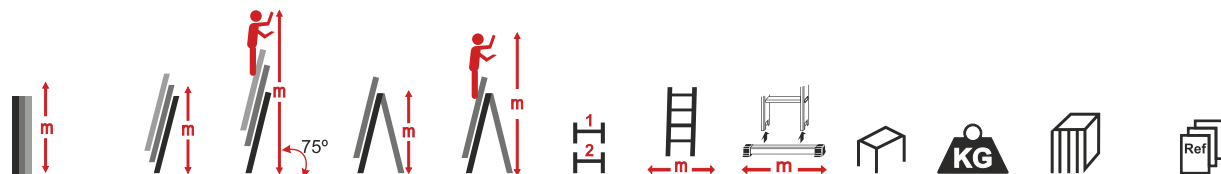

2,00+2,00+2,00	4,50	5,49	2,75	3,74	*3x7	0,470	0,950	66x25	12,00	0,750	A10013020
2,50+2,50+2,50	6,00	6,99	3,25	4,24	*3x9	0,470	1,100	66x25	14,30	0,937	A10013025
3,00+3,00+3,00	7,50	8,49	3,90	4,89	*3x11	0,470	1,200	66x25	17,00	1,125	A10013030
3,50+3,50+3,50	9,00	9,99	4,60	5,59	3x13	0,470	1,200	66x25	20,20	1,312	A10013035
4,00+4,00+4,00	10,50	11,49	5,15	6,14	3x15	0,470	1,200	66x25	23,10	1,500	A10013040

## Translation | Traducción | Traduction

It is a model that allows access to very high heights, it is essential to obtain the necessary stability in its use. It is advisable to check it before each use. Available in version from 2 to 4 meters. - Consisting of 3 sections - Convertible into 2 versions, extendable ladder or ladder. - Built in 65mmx25mm aluminum tube - 28x28mm non-slip tube steps - 250mm distance between steps - Steps firmly embedded in side sections - Stabilizer base with non-slip rubber feet - Plastic plugs on the tops of the profiles - Degree of inclination in use - 65° to 75° - Safety locking system and quick fitting - Excessive anti-opening safety straps - Aluminum sliding system placed on the sides - Safety lashing and extension limiter.

Escaleras Línea Standard L66 en Aluminio - Escalera Triple - Modelo clásico, robusto, muy resistente y fácil de transportar. - La escalera impone varios requisitos de seguridad durante su uso. - Es un modelo que permite el acceso a alturas muy elevadas, es fundamental para obtener la estabilidad necesaria en su uso, es recomendable comprobarlo antes de cada uso. Disponible en versión de 2 a 4 metros. - Consta de 3 secciones - Convertible en 2 versiones, escalera extensible o escalera. - Construido en tubo de aluminio de 65 mm x 25 mm - Escalones de tubo antiderrapantes de 28x28 mm - 250 mm de distancia entre escalones - Pasos firmemente incrustados en las secciones laterales - Base estabilizadora con pies de goma antiderrapantes - Tapones de plástico en la parte superior de los perfiles - Grado de inclinación en uso - 65° a 75° - Sistema de bloqueo de seguridad y montaje rápido - Correas de seguridad anti-abertura excesiva - Sistema de deslizamiento de aluminio colocado en los laterales - Casquilho de seguridad y limitador de extensión.

Échelles Ligne Standard L66 en Aluminium - Échelle Triple - Modèle classique, robuste, très résistant et facile à transporter. - L'échelle impose plusieurs exigences de sécurité lors de son utilisation. - C'est un modèle qui permet d'accéder à des hauteurs très élevées, il est indispensable d'obtenir la stabilité nécessaire à son utilisation. Il est conseillé de le vérifier avant chaque utilisation. - Disponible en version de 2 à 4 mètres. - Composé de 3 sections. - Convertible en 2 versions, échelle extensible ou échelle. - Construit en tube d'aluminium de 65 mm x 25 mm - Marches de tube antidérapantes de 28x28 mm - Distance de 250 mm entre les marches - Marches solidement encastrées dans les sections latérales - Base stabilisatrice avec pieds en caoutchouc antidérapants - Bouchons en plastique sur les sommets des profilés - Degré d'inclinaison en cours d'utilisation - 65° à 75° - Système de verrouillage de sécurité et montage rapide - Sangles de sécurité anti ouverture excessives - Système coulissant en aluminium placé sur les côtés - Douille de sécurité et limiteur d'extension.





# ESCADA SIMPLE LINHA PROFISSIONAL L PROFI EM ALUMÍNIO

SINGLE LADDER PROFESSIONAL LINE L PROFI IN ALUMINIUM | ESCALERA SIMPLE PROFESSIONAL LINE L PROFI EN ALUMINIO | ÉCHELLE SIMPLE PROFESSIONAL LINE L PROFI EN ALUMINIUM

## Características

Modelo clássico, bastante resistente e fácil de transportar. Permite uma grande estabilidade, robustez e segurança de trabalho. Aconselha-se uma verificação antes de cada utilização. Disponível na versão de 3 a 6 metros.

- Construída em tubo de alumínio 80mmx25mm
- Degraus em tubo 30x30mm com relevos antiderrapantes
- Distância de 250mm entre degraus
- Degraus firmemente embutidos às secções laterais
- Base Estabilizadora com pés de borracha antiderrapantes
- Tacos de plástico nos topos dos perfis
- Grau de inclinação em utilização – 65° a 75°
- Capacidade máxima 150 kgs
- Em conformidade com a Norma Europeia 131

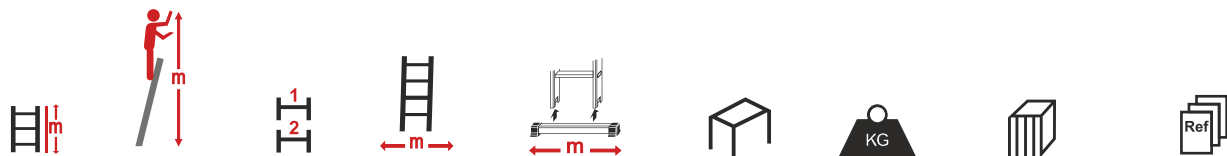
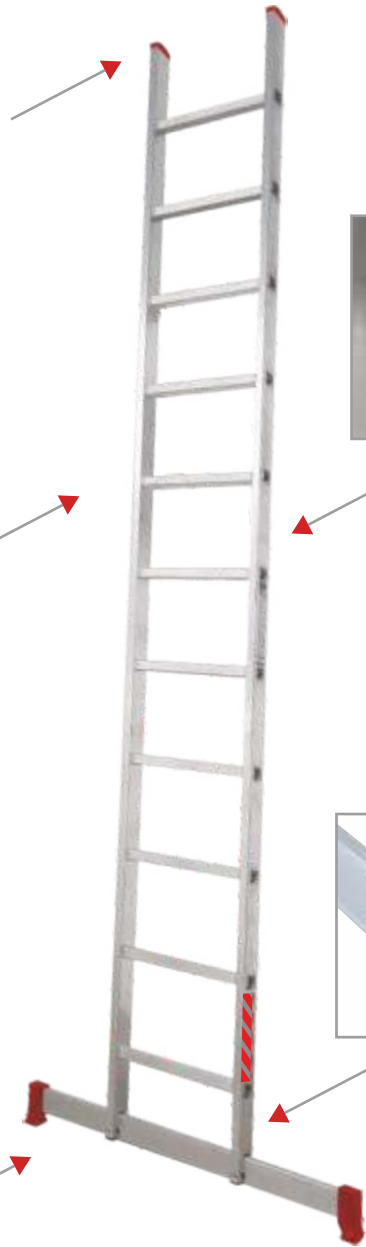
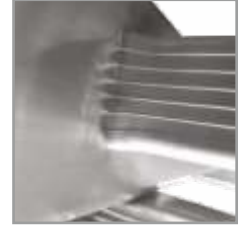
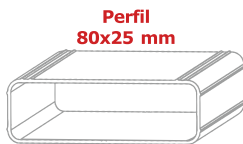
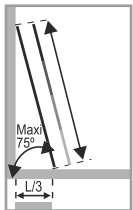
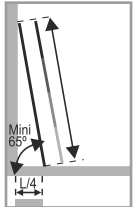
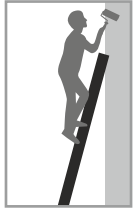

Altura (m)	Comprimento (m)	N.º de degraus	Distância entre degraus (mm)	Distância entre apoios (m)	Perfil (mm)	Peso (kg)	Volume (m³)	Ref.
3,00	3,99	11	0,405	0,950	80x25	6,70	0,270	A11010030
3,50	4,49	13	0,405	0,950	80x25	8,20	0,337	A11010035
4,00	4,99	15	0,405	0,950	80x25	9,40	0,405	A11010040
5,00	5,99	19	0,405	0,950	80x25	12,25	0,472	A11010050
6,00	6,99	23	0,405	1,200	80x25	14,70	0,540	A11010060

## Translation | Traducción | Traduction

Aluminum Ladders Professional Line LProfi - Simple Ladder - Classic model, very resistant and easy to transport. - Allows for great stability, robustness and work safety. It is advisable to check it before each use. - Available in version from 3 to 6 meters. - Built in 80mmx25mm aluminum tube - 30x30mm tube steps with non-slip reliefs - 250mm distance between steps - Steps firmly embedded in side sections - Stabilizer base with non-slip rubber feet - Plastic plugs on the tops of the profiles - Degree of inclination in use - 65° to 75° - Maximum capacity 150 kg - Complies with European Standard 131.

Escaleras Línea Profesional LProfi en Aluminio - Escalera Simple - Modelo clásico, muy resistente y fácil de transportar. - Permite una gran estabilidad, robustez y seguridad laboral. - Es recomendable comprobarlo antes de cada uso. - Disponible en versión de 3 a 6 metros. - Construido en tubo de aluminio de 80 mm x 25 mm - Escalones de tubo de 30x30 mm con relieves antiderrapantes - 250 mm de distancia entre escalones - Pasos firmemente incrustados en las secciones laterales - Base estabilizadora con pies de goma antiderrapantes - Tapones de plástico en la parte superior de los perfiles - Grado de inclinación en uso - 65° a 75° - Capacidad máxima 150 kg - Cumple con el estándar europeo 131.

Échelles Ligne Professionnelle LProfi en Aluminium - Échelle Simple - Modèle classique, très résistant et facile à transporter. - Permet une grande stabilité, robustesse et sécurité de travail. - Il est conseillé de le vérifier avant chaque utilisation. - Disponible en version de 3 à 6 mètres. - Construit en tube d'aluminium de 80 mm x 25 mm - Marches en tube de 30 x 30 mm avec reliefs antidérapants - Distance de 250 mm entre les marches - Marches solidement encastrées dans les sections latérales - Base stabilisatrice avec pieds en caoutchouc antidérapants - Bouchons en plastique sur les sommets des profiles - Degré d'inclinaison en cours d'utilisation - 65° à 75° - Capacité maximale 150 kg - Conforme à la norme européenne 131.



# ESCADA DUPLA LINHA PROFISSIONAL L PROFI EM ALUMÍNIO

L PROFI PROFESSIONAL LINE DOUBLE LADDER IN ALUMINIUM | ESCALERA DOBLE L PROFI PROFESSIONAL LINE EN ALUMINIO | ÉCHELLE DOUBLE L PROFI PROFESSIONAL LINE EN ALUMINIUM

## Características

Modelo robusto, bastante resistente e fácil de transportar. Permite uma elevada estabilidade e segurança de trabalho.

Fácil de montar e utilizar, facilmente adaptável.

Aconselha-se uma verificação antes de cada utilização Disponível na versão de 3 a 6

- Composta por 2 lances.
- Transformável em 2 versões, escada extensível ou escadote
- Construída em tubo de alumínio 80mmx25mm
- Degraus em tubo 30x30mm com relevos antiderrapantes
- Distância de 250mm entre degraus
- Degraus firmemente embutidos às secções laterais
- Base Estabilizadora com pés de borracha antiderrapantes
- Tacos de plástico nos topos dos perfis
- Grau de inclinação em utilização – 65° a 75°
- Sistema de bloqueio de segurança e encaixe rápido
- Precintas de segurança anti abertura excessiva
- Sistema de deslizamento em alumínio colocados às laterais
- Casquilho de segurança e limitador de extensão

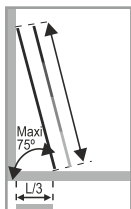
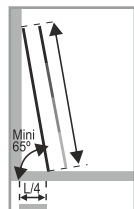
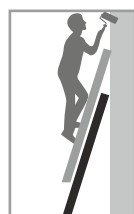

Opção Rodas Superiores

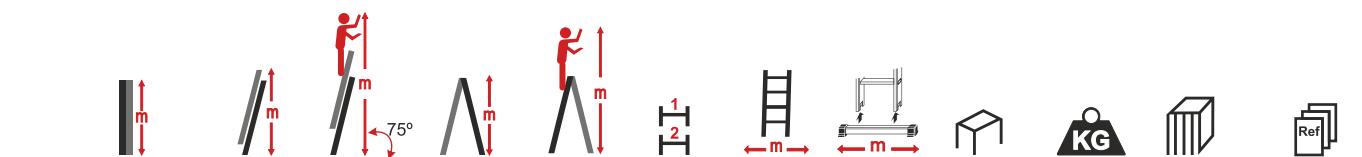
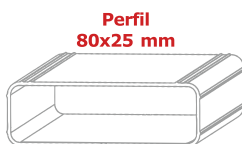

3,00+3,00	5,35	6,34	3,10	4,09	2x11	0,470	0,950	80x25	14,70	0,560	A11011030
3,50+3,50	6,10	7,09	3,45	4,44	2x13	0,470	0,950	80x25	17,70	0,700	A11011035
4,00+4,00	7,40	8,39	4,00	4,99	2x15	0,470	1,100	80x25	20,25	0,840	A11011040
5,00+5,00	9,20	10,19	4,95	5,94	2x19	0,470	1,200	80x25	25,25	0,980	A11011050
6,00+6,00	10,70	11,69	5,80	6,79	2x23	0,470	1,200	80x25	30,29	1,120	A11011060

## Translation | Traducción | Traduction

Aluminum Ladders Professional Line L Profi - Double Ladder - Robust model, very resistant and easy to transport. Provides high stability and work safety. Easy to assemble and use, easily adaptable. - It is advisable to check it before each use. - Available in the 3 to 6 meter version. - Consisting of 2 bids. - Convertible into 2 versions, extendable ladder or ladder. - Built in 80mmx25mm aluminum tube - 30x30mm tube steps with non-slip reliefs - 250mm distance between steps - Steps firmly embedded in side sections - Stabilizer base with non-slip rubber feet - Plastic plugs on the tops of the profiles - Degree of inclination in use - 65° to 75°. Safety locking system and quick fitting - Anti-over-opening safety straps - Aluminium sliding system placed on the sides.

Escaleras Línea Profesional L Profi en Aluminio - Escalera Doble - Modelo robusto, muy resistente y fácil de transportar. Proporciona una gran estabilidad y seguridad en el trabajo. Fácil de montar y utilizar, fácilmente adaptable. - Es recomendable comprobarlo antes de cada uso. - Disponible en versión 3 a 6 - Consta de 2 licitaciones. - Convertible en 2 versiones, escalera extensible o escalera. - Construido en tubo de aluminio de 80 mm x 25 mm - Escalones de tubo de 30x30 mm con relieves antiderrapantes - Distancia de 250 mm entre los escalones - Marches solidamente incrustados en las secciones laterales - Base estabilizadora con pies de goma antiderrapantes - Tapones de plástico en la parte superior de los perfiles - Grado de inclinación en uso - 65° a 75° - Sistema de bloqueo de seguridad y montaje rápido - Correa de seguridad anti-sobrepertura - Sistema de deslizamiento de aluminio colocado en los laterales.

Échelles Ligne Professionnelle L Profi en Aluminium - Echelle Double - Modèle robuste, très résistant et facile à transporter. Fournit une stabilité élevée et une sécurité de travail. Facile à assembler et à utiliser, facilement adaptable. - Il est conseillé de le vérifier avant chaque utilisation. - Disponible en version 3 à 6 - Composé de 2 offres. - Convertible en 2 versions, échelle extensible ou échelle. - Construit en tube d'aluminium de 80 mm x 25 mm - Marches en tube de 30x30 mm avec reliefs antidérapants - Distance de 250 mm entre les marches - Marches solidement encastrées dans les sections latérales - Base stabilisatrice avec pieds en caoutchouc antidérapants - Bouchons en plastique sur les sommets des profils - Degré d'inclinaison en cours d'utilisation - 65° à 75° - Système de verrouillage de sécurité et montage rapide - Sangles de sécurité anti-ouverture - Système coulissant en aluminium placé sur les côtés.



# ESCADA DUPLA C/CORDA LINHA PROFISSIONAL L PROFI EM ALUMÍNIO

DOUBLE LADDER WITH ROPE PROFESSIONAL LINE L PROFI IN ALUMINIUM | ESCALERA DOBLE CON CUERDA PROFESSIONAL LINE L PROFI EN ALUMINIO | ÉCHELLE DOUBLE A CORDE PROFESSIONAL LINE L PROFI EN ALUMINIUM

## Características

Modelo clássico, robusto, bastante resistente e fácil de transportar.

O sistema da corda facilita a extensão da escada e bloqueia a escada na altura pretendida, impedindo que a secção superior deslize.

Aconselha-se uma verificação antes de cada utilização.

Disponível na versão de 3 a 6 metros.

- Composta por 2 lances
- Construída em tubo de alumínio 80mmx25mm
- Degraus em tubo 30x30 mm antiderrapantes
- Distância de 250mm entre degraus
- Degraus firmemente embutidos às secções laterais
- Base Estabilizadora com pés de borracha antiderrapantes
- Sistema de bloqueio de segurança e encaixe rápido
- Precintas de segurança anti abertura excessiva
- Sistema de deslizamento em alumínio colocados as laterais
- Casquilho de segurança e limitador de extensão
- Tacos de plástico nos topos dos perfis
- Grau de inclinação em utilização – 65° a 75°

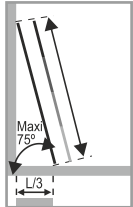
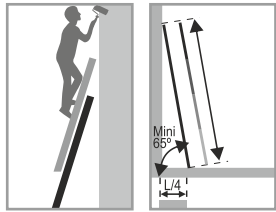

Opção Rodas Superiores

Degrau 30x30 mm

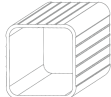

Perfil 80x25 mm

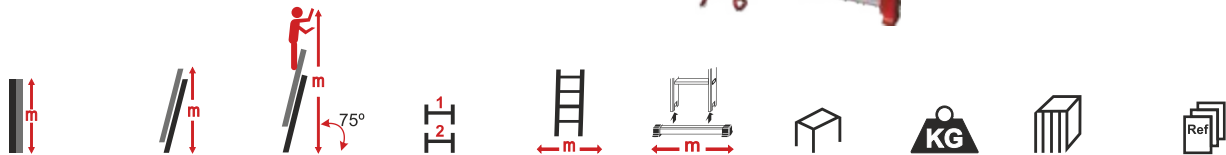
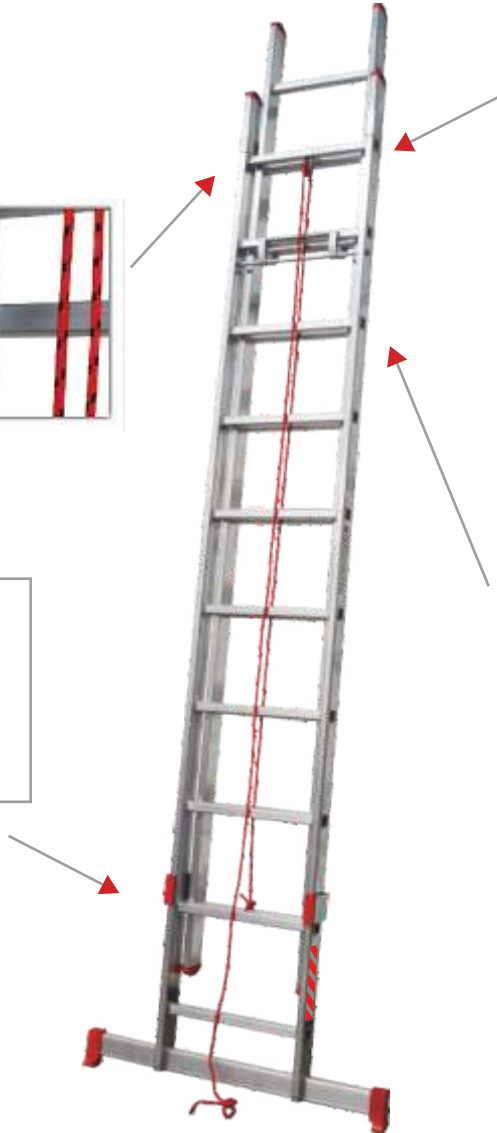
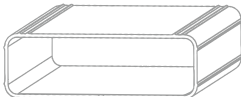

3,00+3,00	5,35	6,34	2x11	0,470	0,950	80x25	15,70	0,560	A11012030
3,50+3,50	6,10	7,09	2x13	0,470	0,950	80x25	18,70	0,700	A11012035
4,00+3,00	7,40	8,39	2x15	0,470	1,100	80x25	21,25	0,840	A11012040
5,00+5,00	9,20	10,19	2x19	0,470	1,200	80x25	26,25	0,980	A11012050
6,00+6,00	10,70	11,69	2x23	0,470	1,200	80x25	30,29	1,120	A11012060

## Translation | Traducción | Traduction

Aluminum Ladders Professional Line LProfi - Double Ladder w/ Rope - Classic model, robust, very resistant and easy to transport. - Rope system facilitates ladder extension and locks the ladder at the desired height, preventing the upper section from sliding. Checking is advised before each use. - Available in version from 3 to 6 meters. - Consisting of 2 sections - Built in 80mmx25mm aluminum tube - 30x30mm non-slip tube steps - 250mm distance between steps - Steps firmly embedded in the side sections - Stabilizer base with non-slip rubber feet - Safety locking system and quick fitting - Anti-over-opening safety straps - Aluminum sliding system placed on the sides - Safety bushing and extension limiter - Plastic plugs on the tops of the profiles - Degree of inclination in use - 65° to 75°.

Escaleras Línea Profesional LProfi en Aluminio - Escalera Doble C/ Cuerda - Modelo clásico, robusto, muy resistente y fácil de transportar. - El sistema de cuerda facilita la extensión de la escalera y bloquea a la escalera a la altura deseada, evitando que la sección superior se deslice. - Se recomienda realizar una comprobación antes de cada uso. - Disponible en versión de 3 a 6 metros. - Consta de 2 secciones - Construido en tubo de aluminio de 80 mm x 25 mm - Escalones de tubo antiderrapantes de 30x30 mm - 250 mm de distancia entre escalones - Pasos firmemente incrustados en las secciones laterales - Base estabilizadora con pies de goma antiderrapantes - Sistema de bloqueo de seguridad y montaje rápido - Correas de seguridad anti-sobreapertura - Sistema de deslizamiento de aluminio colocado en los laterales - Casquillo de seguridad y limitador de extensión - Tapones de plástico en la parte superior de los perfiles - Grado de inclinación en uso - 65° a 75°.

Échelles Ligne Professionnelle LProfi en Aluminium - Échelle Double avec Corde - Modèle classique, robuste, très résistant et facile à transporter. - Le système de corde facilite l'extension de l'échelle et verrouille l'échelle à la hauteur souhaitée, empêchant la partie supérieure de glisser. - Un contrôle est conseillé avant chaque utilisation. - Disponible en version de 3 à 6 mètres. - Composé de 2 sections - Construit en tube d'aluminium de 80 mm x 25 mm - Marches de tube antidérapantes de 30x30 mm - Distance de 250 mm entre les marches - Marches solidement encastrées dans les sections latérales - Base stabilisatrice avec pieds en caoutchouc antidérapants - Système de verrouillage de sécurité et montage rapide - Sangles de sécurité anti-ouverture - Système coulissant en aluminium placé sur les côtés - Douille de sécurité et limiteur d'extension - Bouchons en plastique sur les sommets des profilés - Degré d'inclinaison en cours d'utilisation - 65° à 75°.



# ESCADA TRIPLA LINHA PROFISSIONAL L PROFI EM ALUMÍNIO

L PROFI PROFESSIONAL LINE TRIPLE LADDER IN ALUMINUM | ESCALERA TRIPLA CON CUERDA PROFESSIONAL LINE L PROFI EN ALUMINIO | ÉCHELLE TRIPLE L PROFI PROFESSIONAL LINE EN ALUMINIUM

## Características

Modelo robusto, bastante resistente e fácil de transportar.

A escada obriga a vários requisitos de segurança durante a sua utilização. É um modelo que permite o acesso a alturas muito elevadas, é fundamental obter a estabilidade necessária na sua utilização. Aconselha-se uma verificação antes de cada utilização.

Disponível na versão de 3 a 6 metros.

- Composta por 3 lances
- Transformável em 2 versões, escada extensível ou escadote
- Construída em tubo de alumínio 80mmx25mm
- Degraus em tubo 30x30mm antiderrapantes
- Distância de 250mm entre degraus
- Degraus firmemente embutidos às secções laterais
- Base Estabilizadora com pés de borracha antiderrapantes
- Tacos de plástico nos topos dos perfis
- Grau de inclinação em utilização - 65° a 75°
- Sistema de bloqueio de segurança e encaixe rápido
- Precintas de segurança antiabertura excessiva
- Sistema de deslizamento em alumínio colocados as laterais
- Casquilho de segurança e limitador de extensão

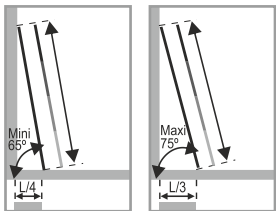
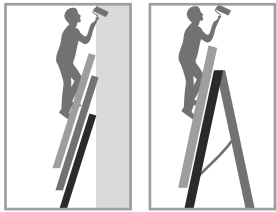

Opção Rodas Superiores

Degrau 30x30 mm

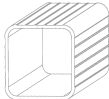

Perfil 80x25 mm

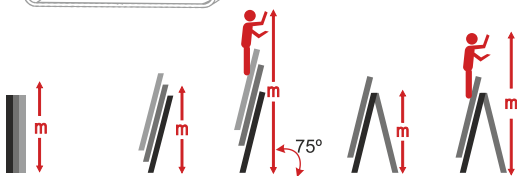
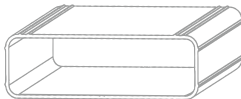

3,00+3,00+3,00	7,70	8,69	5,35	6,34	3x11	0,470	1,200	80x25	19,00	0,750	A11013030
3,50+3,50+3,50	9,10	10,09	6,12	7,11	3x13	0,470	1,200	80x25	24,00	0,937	A11013035
4,00+4,00+4,00	10,45	11,44	6,90	7,89	3x15	0,470	1,200	80x25	27,00	1,125	A11013040
5,00+5,00+5,00	13,10	14,09	8,90	9,89	3x19	0,470	1,200	80x25	33,40	1,312	A11013050
6,00+6,00+6,00	15,52	16,51	9,80	10,79	3x23	0,470	1,200	80x25	35,00	1,500	A11013060

## Translation | Traducción | Traduction

**EN** Aluminum Ladders Professional Line LProfi - Triple Ladder - Robust model, very resistant and easy to transport. - The ladder imposes several safety requirements during its use. - It is a model that allows access to very high heights, it is essential to obtain the necessary stability in its use. - It is advisable to check it before each use. - Available in version from 3 to 6 meters. - Consisting of 3 bids - Convertible into 2 versions, extendable ladder or ladder - Built in 80mmx25mm aluminum tube - 30x30mm non slip tube steps - 250mm distance between steps - Steps firmly embedded in side sections - Stabilizer base with non-slip rubber feet - Plastic plugs on the tops of the profiles - Degree of inclination in use - 65° to 75° - Safety locking system and quick fitting - Excessive anti-opening safety straps - Aluminum sliding system placed on the sides.

**ES** Escaleras Línea Profesional LProfi en Aluminio - Escalera Triple - Modelo robusto, muy resistente y fácil de transportar. - La escalera impone varios requisitos de seguridad durante su uso. - Es un modelo que permite el acceso a alturas muy elevadas, es fundamental para obtener la estabilidad necesaria en su uso, es recomendable comprobarlo antes de cada uso. - Disponible en versión de 3 a 6 metros. - Consta de 3 ofertas - Convertible en 2 versiones, escalera extensible o escalera - Construido en tubo de aluminio de 80 mm x 25 mm - Escalones de tubo antiderrapantes de 30x30 mm - 250 mm de distancia entre escalones - Pasos firmemente incrustados en las secciones laterales - Base estabilizadora con pies de goma antiderrapantes - Tapones de plástico en la parte superior de los perfiles - Grado de inclinación en uso - 65° a 75° - Sistema de bloqueo de seguridad y montaje rápido - Correas de seguridad anti-apertura excesivas - Sistema de deslizamiento de aluminio colocado en los laterales - Casquillo de seguridad y limitador de extensión.

**FR** Échelles Ligne Professionnelle LProfi en Aluminium - Échelle Triple - Modèle robuste, très résistant et facile à transporter. - L'échelle impose plusieurs exigences de sécurité lors de son utilisation. - C'est un modèle qui permet d'accéder à des hauteurs très élevées, il est indispensable d'obtenir la stabilité nécessaire à son utilisation. - Il est conseillé de le vérifier avant chaque utilisation. - Disponible en version de 3 à 6 mètres. - Composée de 3 offres - Convertible en 2 versions, échelle extensible ou échelle - Construit en tube d'aluminium de 80 mm x 25 mm - Marches de tube antidérapantes de 30 x 30 mm - Distance de 250 mm entre les marches - Marches solidement encastrées dans les sections latérales - Base stabilisatrice avec pieds en caoutchouc antidérapants - Bouchons en plastique sur les sommets des profils - Degré d'inclinaison en cours d'utilisation - 65° à 75° - Système de verrouillage de sécurité et montage rapide - Sangles de sécurité anti-ouverture excessives - Système coulissant en aluminium placé sur les côtés - Bague de sécurité et limiteur d'extension.



# ESCADA FIBRA F66 (ALUMÍNIO + FIBRA VIDRO)

FIBER LADDER F66 (ALUMINIUM + FIBERGLASS) | ESCALERA DE FIBRA F66 (ALUMINIO + FIBRA DE VIDRIO) | ÉCHELLE EN FIBRE F66 (ALUMINIUM + FIBRE DE VERRE)

## Características

Modelo clássico, robusto, bastante resistente e fácil de transportar.

A escada obriga a vários requisitos de segurança durante a sua utilização.

Aconselha-se uma verificação antes de cada utilização.

Disponível na versão de 2,5 a 4 metros.

- Composta por 3 lances
- 2 lances em alumínio e um tramo em fibra de vidro com isolamento eléctrico
- Transformável em 2 versões, escada extensível ou escadote
- Construída em tubo de alumínio 65mmx25mm
- Degraus em tubo de alumínio 30x30mm antiderrapantes
- Distância de 300 mm entre degraus
- Degraus firmemente embutidos às secções laterais
- Base Estabilizadora com pés de borracha antiderrapantes
- Tacos de plástico nos topos dos perfis
- Grau de inclinação em utilização – 65° a 75°
- Sistema de bloqueio de segurança e encaixe rápido
- Precintas de segurança antiabertura excessiva
- Sistema de deslizamento em alumínio colocados as laterais
- Casquilho de segurança e limitador de extensão
- Sistema de deslizamento em alumínio colocados as laterais
- Casquilho de segurança e limitador de extensão

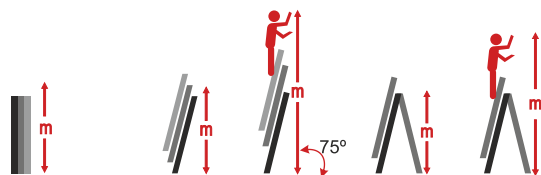
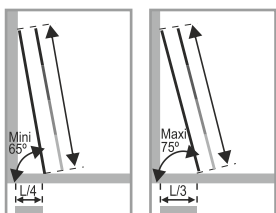
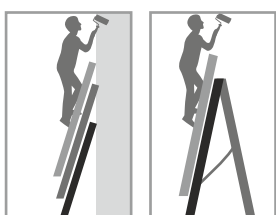

2,50+2,50+2,50	6,00	6,99	3,25	4,24	3x9	1,100	66x25	15,50	0,937	A11513025	
3,00+3,00+3,00	7,50	8,49	3,90	4,89	3x10	1,200	66x25	18,50	1,125	A11513030	
3,50+3,50+3,50	9,00	9,99	4,60	5,59	3x12	1,200	66x25	21,00	1,312	A11513035	
4,00+4,00+4,00	10,50	11,49	5,15	6,14	3x14	1,200	66x25	24,50	1,500	A11513040	

## Translation | Traducción | Traduction

**UK** Fiber Ladder F66 (Aluminium + Fiberglass) - Classic model, robust, very resistant and easy to transport. - The ladder has several safety requirements during its use. It is advisable to check it before each use. - Available in version from 2.5 to 4 meters - Consisting of 3 bids - 2 aluminum flights and a fiberglass section with electrical insulation - Convertible into 2 versions, extendable ladder or ladder - Built in 65mmx25mm aluminum tube - 30x30mm non-slip aluminum tube steps - Distance of 300mm between steps - Steps firmly embedded in side sections - Stabilizer base with non-slip rubber feet - Plastic plugs on the tops of the profiles - Degree of inclination in use - 65° to 75° - Safety locking system and quick fitting.

**ES** Escalera Fibra F66 (Aluminio + Fibra Vidrio) - Modelo clásico, robusto, muy resistente y fácil de transportar. - La escalera tiene varios requisitos de seguridad durante su uso. Es recomendable revisarla antes de cada uso. - Disponible en versión de 2,5 a 4 metros - Consta de 3 ofertas - 2 tramos de aluminio y un tramo de fibra de vidrio con aislamiento eléctrico - Convertible en 2 versiones, escalera extensible o escalera - Construida en tubo de aluminio de 65mm x 25mm - Escalones de tubo de aluminio antiderrapante de 30x30mm - Distancia de 300mm entre escalones - Pasos firmemente incrustados en las secciones laterales - Base estabilizadora con pies de goma antiderrapantes - Tapones de plástico en la parte superior de los perfiles - Grado de inclinación en uso - 65° a 75° - Sistema de bloqueo de seguridad y montaje rápido.

**FR** Échelle Fibre F66 (Aluminium + Fibre Verre) - Modèle classique, robuste, très résistant et facile à transporter. - L'échelle a plusieurs exigences de sécurité lors de son utilisation. - Il est conseillé de la vérifier avant chaque utilisation. - Disponible en version de 2,5 à 4 mètres - Composée de 3 offres - 2 volées en aluminium et une section en fibre de verre avec isolation électrique - Convertible en 2 versions, échelle extensible ou échelle - Construite en tube d'aluminium de 65mm x 25mm - Marches en tube d'aluminium antidérapant de 30x30mm - Distance de 300mm entre les marches - Marches solidement encastrées dans les sections latérales - Base stabilisatrice avec pieds en caoutchouc antidérapants - Bouchons en plastique sur les sommets des profils - Degré d'inclinaison en cours d'utilisation - 65° à 75° - Système de verrouillage de sécurité et montage rapide.





# ESCALA COMFORT EM ALUMÍNIO

ALUMINUM COMFORT LADDER | ESCALERA DE CONFORT DE ALUMINIO |  
ÉCHELLE DE CONFORT EN ALUMINIUM

## Características

Modelo bastante resistente e fácil de transportar.  
Permite a utilização por períodos mais prolongados devido a largura do degrau.  
Grande estabilidade, robustez e segurança de trabalho.

Aconselha-se uma verificação antes de cada utilização

- Construída em tubo de alumínio 65mmx25mm
- Degrau antiderrapante com 86 mm em alumínio
- Degraus firmemente embutidos às secções laterais
- Opção Base Estabilizadora com pés de borracha antiderrapantes
- Tacos de plástico nos topos dos perfis
- Grau de inclinação em utilização – 65° a 75°
- Capacidade máxima 150 kgs

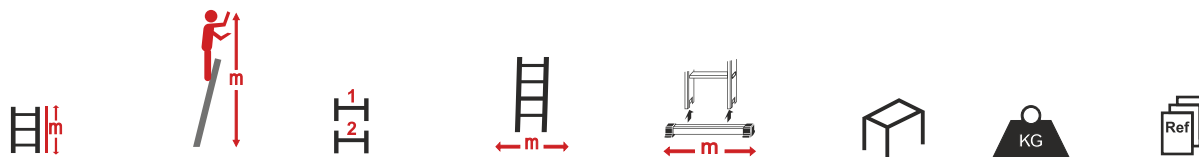
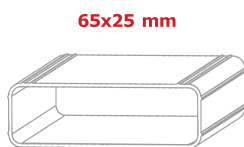
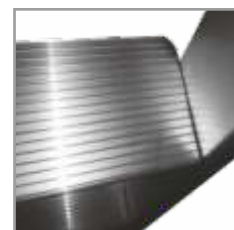
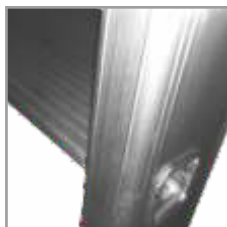
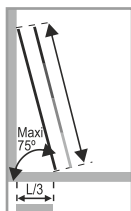
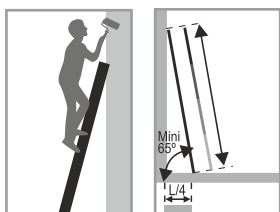

Altura	Largura do Degrau	Nº de Degraus	Largura do Perfil	Comprimento do Perfil	Altura da Base	Peso	Referência
2,00	2,99	7	0,400	-	66x25	4,50	A12010020
2,50	3,49	9	0,400	-	66x25	5,60	A12010025
3,00	3,99	11	0,400	0,950	66x25	6,80	A12010030
3,50	4,49	13	0,400	0,950	66x25	8,50	A12010035
4,00	4,99	15	0,400	0,950	66x25	9,60	A12010040
5,00	5,99	19	0,400	0,950	66x25	12,00	A12010050

## Translation | Traducción | Traduction

Aluminum Comfort Ladder - Very resistant and easy to transport model. - Allows use for longer periods due to the width of the step. - Great stability, robustness and work safety. - It is advisable to check it before each use. - Built in 65mmx25mm aluminum tube - 86 mm non-slip aluminum step - Steps firmly embedded in side sections - Stabilizer base option with non-slip rubber feet - Plastic plugs on the tops of the profiles - Degree of inclination in use - 65° to 75° - Maximum capacity 150 kg.

Escalera Comfort en Aluminio - Modelo muy resistente y fácil de transportar. - Permite su uso por períodos más prolongados debido al ancho del escalón. - Gran estabilidad, robustez y seguridad laboral. - Es recomendable comprobarlo antes de cada uso. - Construido en tubo de aluminio de 65 mm x 25 mm - Peldaño de aluminio antideslizante de 86 mm - Pasos firmemente incrustados en las secciones laterales - Opción de base estabilizadora con pies de goma antideslizantes - Tapones de plástico en la parte superior de los perfiles - Grado de inclinación en uso - 65° a 75° - Capacidad máxima 150 kg.

Échelle Comfort en Aluminium - Modèle très résistant et facile à transporter. - Permet une utilisation plus longue en raison de la largeur de la marche. - Grande stabilité, robustesse et sécurité de travail. - Il est conseillé de le vérifier avant chaque utilisation. - Construit en tube d'aluminium de 65 mm x 25 mm - Marche en aluminium antidérapante de 86 mm - Marches solidement encastrées dans les sections latérales - Option de base stabilisatrice avec pieds en caoutchouc antidérapants - Bouchons en plastique sur les sommets des profilés - Degré d'inclinaison en cours d'utilisation - 65° à 75° - Capacité maximale de 150 kg.



# GAMA

## ESCADAS MULTIFUNÇÕES

- Multiusos
- Multiposições M75
- Multiposições em Ferro



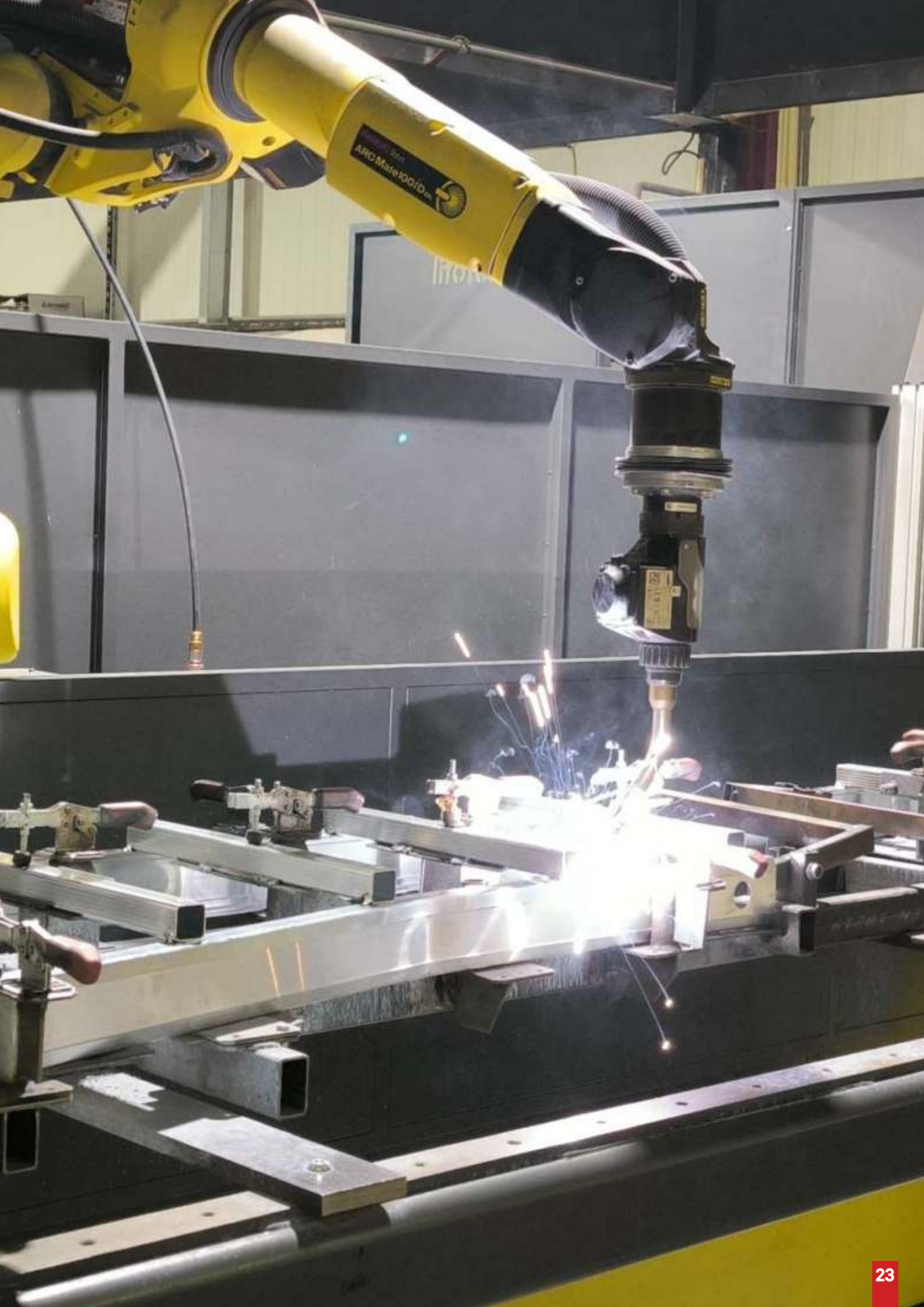



# ESCALA MULTIPOSIÇÕES M75 EM ALUMÍNIO

MULTIPOSITION LADDER M75 IN ALUMINUM | ESCALERA MULTIPOSICIÓN M75 EN ALUMINIO | ÉCHELLE MULTIPOSITION M75 EN ALUMINIUM



## Características

- Extremamente versátil e de posicionamento rápido.
- Peso reduzido
- Fácil de manusear, transportar e armazenar
- Utilização em pisos desnivelados
- Sistema de segurança autobloqueio para as diversas posições
- Regulação de altura através de dispositivo de bloqueio no degrau.
- Perfil lateral em alumínio
- Interior 65x25mm c/ degrau secção 28x28mm rebordados
- Exterior 75x30mm c/ degrau secção 30x30mm soldados
- Degraus com relevo antiderrapante soldados
- Tacos robustos e antiderrapantes
- Disponível nas versões de 3 a 6 degraus por lance

Posição escada (≈180°) Posição escadote (≈30°) Posição fechada

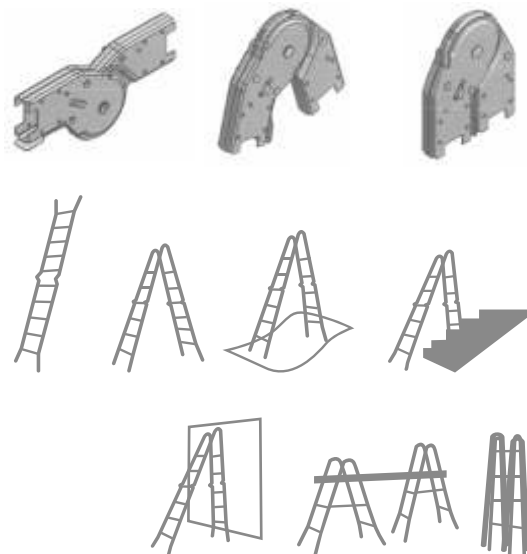

Steps	Weight (kg)	Open Height (m)	Open Length (m)	Extended Length (m)	Extended Height (m)	Footprint (mm)	Weight (kg)	Reference
4x3	0,91	1,40	2,40	2,77	3,92	66x25	8,50	A10750003
4x4	1,17	1,68	3,28	3,26	4,92	66x25	10,20	A10750004
4x5	1,42	1,93	3,74	3,75	5,92	66x25	12,50	A10750005
4x6	1,68	2,54	4,23	4,35	6,41	66x25	14,00	A10750006

## Translation | Traducción | Traduction

Multi-Position M75 Aluminium Ladder - Extremely versatile and quick to position. - Reduced weight - Easy to handle, transport and store - Use on uneven floors - Self-locking safety system for different positions. - Height adjustment via step lock device. - Aluminum side profile - Interior 65x25mm w/ step 28x28mm edging - Outside 75x30mm - Outside w/ step 30x30mm welded - Sections with non-slip relief welded - Robust, non-slip clubs - Available in versions from 3 to 6 steps per flight.

Escalera Multi-posiciones M75 en Aluminio - Extremadamente versátil y rápido de colocar. - Peso reducido - Fácil de manipular, transportar y almacenar - Usar en suelos irregulares. - Sistema de seguridad autobloqueante para diferentes posiciones. Ajuste de altura mediante dispositivo de bloqueo escalonado. - Perfil lateral de aluminio - Interior 65x25mm c/ escalón 28x28mm ribete - Exterior 75x30mm - Exterior c/ escalón 30x30mm soldado - Secciones con relieve antiderrapante soldado - Pisos robustos y antiderrapantes - Disponible en versiones de 3 a 6 pasos por vuelo.

Échelle Multi-Positions M75 en Aluminium - Extrêmement polyvalente et rapide à positionner. - Poids réduit. - Facile à manipuler, transporter et stocker - Utilisation sur sols irréguliers. - Système de sécurité autobloquant pour différentes positions. Réglage de la hauteur via un dispositif de verrouillage par marche. - Profil latéral en aluminium - Intérieur 65x25mm avec marche 28x28mm - Extérieur 75x30mm - Extérieur avec marche 30x30mm soudé - Sections avec relief antidérapant soudé - Clubs robustes et antidérapants - Disponible en versions de 3 à 6 pas par vol.



**SOLDADURA ROBOTIZADA**  
ROBOTIZED WELDING  
SOLDADURA ROBOTIZADA  
SOUDURE ROBOTISÉE



# ESCADA MULTIPOSIÇÕES BS 36 EM ALUMÍNIO

MULTIPOSITION LADDER BS 36 IN ALUMINUM | ESCALERA MULTIPOSICIÓN BS 36 EN ALUMINIO | ÉCHELLE MULTIPOSITION BS 36 EN ALUMINIUM

## Características

- Extremamente versátil e de posicionamento rápido
- Peso reduzido
- Fácil de manusear, transportar e armazenar
- Utilização em pisos desnivelados
- Sistema de segurança autobloqueio para as diversas posições
- Regulação de altura através de dispositivo de bloqueio no degrau
- Limitador de extensão
- Perfil lateral em alumínio
- Interior 65x25mm c/degrau secção 28x28mm rebordados
- Exterior 75x30mm c/degrau secção 30x30mm soldados
- Degraus com relevo antiderrapante soldados
- Base estabilizadora com tacos antiderrapantes
- Disponível nas versões de 3 a 6 degraus por lance

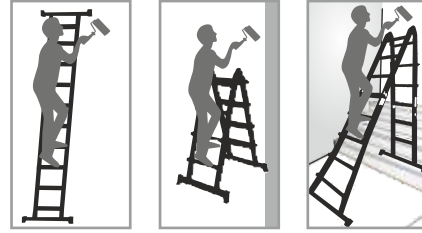
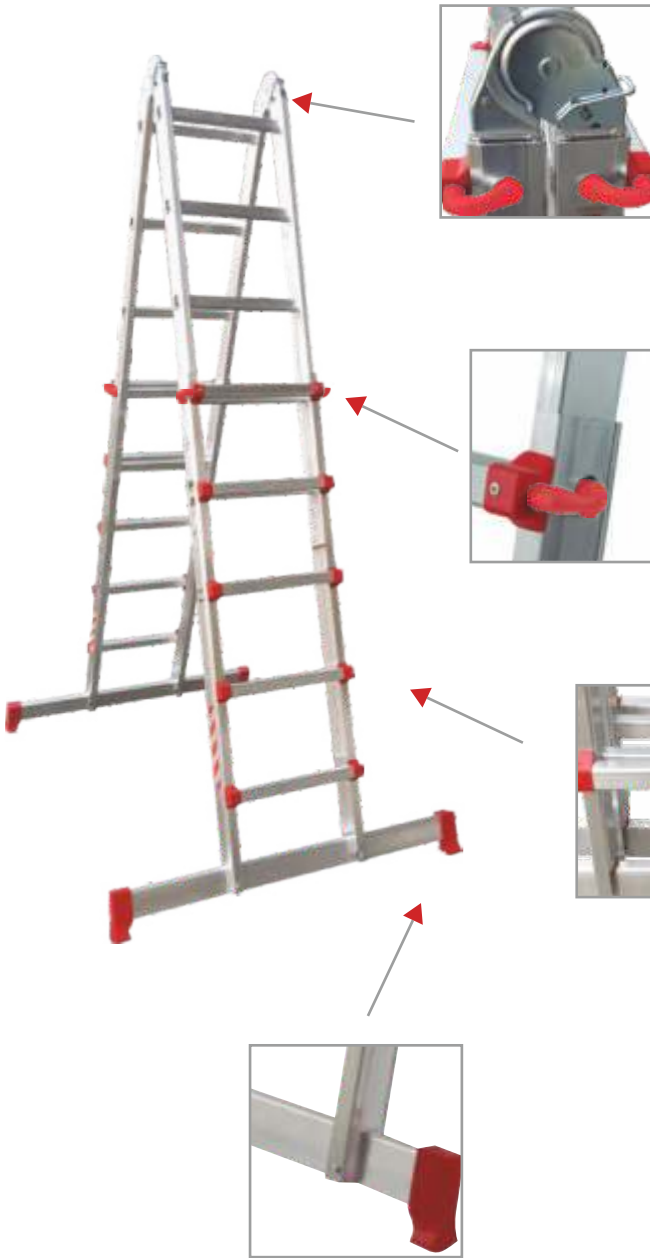

Posição escada (≈180°)

Posição escadote (≈30°)

Posição fechada

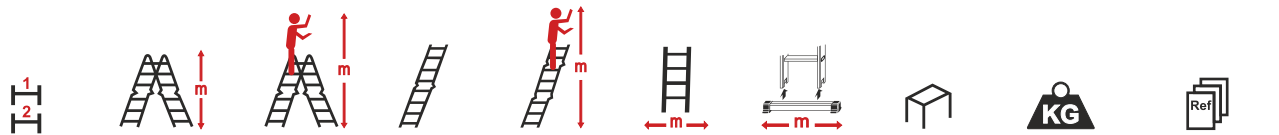

	1 2								KG	Ref
4x3	1,39	2,84	2,73	3,92	0,380	0,620	66x25	9,20	A10600003	
4x4	1,88	3,33	3,72	4,92	0,380	0,950	66x25	10,80	A10600004	
4x5	2,34	3,79	4,73	5,92	0,380	0,950	66x25	12,50	A10600005	
4x6	2,82	4,27	5,22	6,41	0,380	0,950	66x25	14,30	A10600006	

## Translation | Traducción | Traduction

Multi-Position BS 36 Aluminum Ladder - Extremely versatile and secure - Various positions of use - Platform, Bench, Ladder and Ladder Reduced weight - Easy to handle, transport and store - Self-locking safety system for different positions Anti-slip stabilizer bases - Aluminum side profile 65x25mm section with non-slip relief Stabilizer base with non-slip rubber feet Available in versions from 3 to 5 steps per section - Option for use with metal platform.

Escalera Multi-posiciones BS 36 en Aluminio - Extremadamente versátil y seguro - Varias posiciones de uso: plataforma, banco, escalera y escalera • Peso reducido - Fácil de manipular, transportar y almacenar - Sistema de seguridad autobloqueante para diferentes posiciones • Bases estabilizadoras antiderrapantes - Perfil lateral de aluminio sección 65x25mm - Peldaño de aluminio Sección de 28x28 mm con relieve antiderrapante - Base estabilizadora con pies de goma antiderrapante - Disponible en versiones de 3 a 5 peldaños por sección - Opción de uso con plataforma metálica.

Échelle Multi-Positions BS 36 en Aluminium - Extrêmement polyvalent et sécurisé - Différentes positions d'utilisation - Plateforme, Banc, Echelle et Echelle Poids réduit - Facile à manipuler, transporter et stocker - Système de sécurité autobloquant pour différentes positions - Bases stabilisatrices antidérapantes - Profilé latéral en aluminium section 65x25mm - Marche en aluminium Section 28x28mm avec relief antidérapant - Base stabilisatrice avec pieds en caoutchouc antidérapant - Disponible en versions de 3 à 5 marches par section - Option pour une utilisation avec une plate-forme en métal.



**SOLDADURA ROBOTIZADA**  
ROBOTIZED WELDING  
SOLDADURA ROBOTIZADA  
SOUDURE ROBOTISÉE

# ESCADA MULTIPOSIÇÕES EM FERRO

IRON MULTIPOSITION LADDER | ESCALERA MULTIPOSICIÓN DE HIERRO | ÉCHELLE MULTIPOSITION EN FER

## Características

Disponível na versão de 4 degraus por segmento.

- Fácil regulação de altura através de dispositivo de bloqueio
- Utilização em pisos desnivelados
- Tacos robustos antiderrapantes
- Peso reduzido.
- Extremamente versátil
- Posicionamento rápido
- Fácil de transportar e armazenar
- Degrau secção 15x15x1
- Perfil lateral interior 40x20 mm
- Perfil lateral exterior 45x22 mm

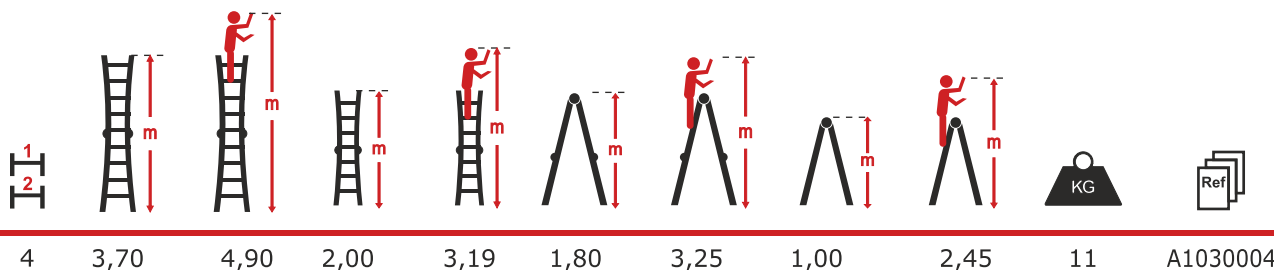
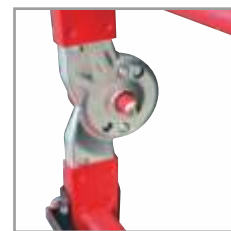
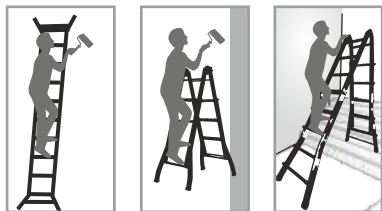

## Translation | Traducción | Traduction

Multi-Position Steel Ladder - Available in the version with 4 steps per segment. - Easy height adjustment through locking device - Use on uneven floors - Robust non-slip putters - Reduced weight. - Extremely versatile - Fast positioning - Easy to transport and store - Step 15x15x1 section - 40x20 mm inner side profile - Exterior side profile 45x22 mm.

Escalera Multi-posiciones en Hierro - Disponible en la versión con 4 pasos por segmento. - Fácil ajuste de altura mediante dispositivo de bloqueo - Úselo en suelos irregulares - Putteres robustos y antideslizantes - Peso reducido. - Extremadamente versátil - Posicionamiento rápido - Fácil de transportar y almacenar - Paso sección 15x15x1 - Perfil lateral interior de 40x20 mm - Perfil lateral exterior 45x22 mm

Échelle Multi-Positions en Fer - Disponible dans la version avec 4 marches par segment. - Réglage facile de la hauteur grâce au dispositif de verrouillage - Utiliser sur des sols inégaux - Putteres antidérapants robustes - Poids réduit. - Extrêmement polyvalent - Positionnement rapide - Facile à transporter et à ranger - Section étape 15x15x1 - Profil latéral intérieur 40x20 mm - Profil latéral extérieur 45x22 mm



# GAMA

## ESCADOTES EM ALUMÍNIO

- **Z40** – Frente 40, degrau em chapa 80
- **STANDARD** – Frente 50, degrau 80
- **BR50** – Porta ferramentas
- **REFORÇADO** – Costa reforçada
- **R120** – Degrau extra largo 120, costa reforçada
- **POTENTE** – Soldadura robotizada, máxima robustez
- **TABURETE** – Ideal para trabalho pouca altura
- **DUPLO DOMÉSTICO** – Duplo acesso
- **MÓVEL** – Com plataforma, degrau extra largo, rodas





# ESCADOTE Z40 DEGRAUS EM CHAPA ZINCADA EM ALUMÍNIO

Z40 STEP LADDER IN ALUMINIUM ZINC PLATED SHEET | ESCALERA Z40 EN CHAPA DE ALUMINIO ZINCADO | ESCABEAU Z40 EN TÔLE D'ALUMINIUM ZINGUÉ

## Características

- Disponível na versão de 2 a 8 degraus
- Fácil transporte e armazenamento
- Tampo superior antiderrapante em aço tratado com sistema de bloqueio
- Tacos de apoio em PVC antiderrapante
- Precintas de segurança antiabertura nas versões de 5 a 8 degraus
- Degrau antiderrapante com 80mm em chapa zincada com capas de proteção
- Perfil alumínio Frente 40x20mm
- Perfil alumínio Costas 33x20mm

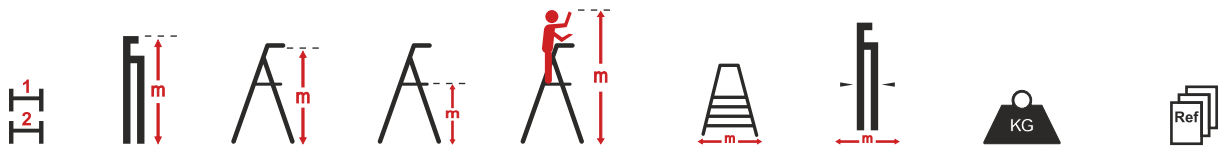
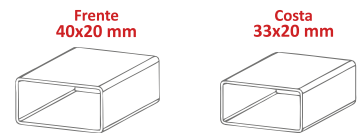

1	2	3	4	5	6	7	8	9	10
2	1,070	0,980	0,385	2,385	0,400	0,120	2,80	A2000042	
3	1,320	1,220	0,620	2,620	0,420	0,120	3,80	A2000043	
4	1,560	1,460	0,860	2,860	0,440	0,120	4,50	A2000044	
5	1,810	1,700	1,130	3,130	0,460	0,120	5,80	A2000045	
6	2,050	1,940	1,340	3,340	0,480	0,120	6,70	A2000046	
7	2,300	2,180	1,570	3,570	0,500	0,120	7,80	A2000047	
8	2,540	2,420	1,795	3,795	0,520	0,120	8,50	A2000048	

## Translation | Traducción | Traduction

Z40 Aluminium Step ladder (Galvanized sheet steps) - Available in version from 2 to 8 steps - Easy transport and storage - Non-slip top top in treated steel with locking system - Support blocks in non-slip PVC - Anti-opening safety straps in versions from 5 to 8 steps - 80mm non-slip step in zinc plated sheet with protective covers - Front aluminum profile 40x20mm - Aluminum profile Back 33x20mm.

Escalera Tijera Z40 en Aluminio (peldaños de chapa galvanizada) - Disponible en versión de 2 a 8 pasos - Fácil transporte y almacenamiento - Tapa superior antideslizante en acero tratado con sistema de bloqueo - Bloques de soporte en PVC antideslizante - Correas de seguridad anti-apertura en versiones de 5 a 8 pasos - Peldaño antideslizante de 80 mm en chapa galvanizada con cubiertas protectoras - Perfil de aluminio frontal 40x20mm - Perfil de aluminio Atrás 33x20mm.

Escabeau Z40 en Aluminium (marches en tôle galvanisée) - Disponible en version de 2 à 8 marches - Transport et stockage faciles - Dessus antidérapant en acier traité avec système de verrouillage - Blocs de support en PVC antidérapant - Sangles de sécurité anti-ouverture dans les versions de 5 à 8 marches - Marche antidérapante de 80 mm en tôle galvanisée avec capots de protection - Profilé avant en aluminium 40x20mm - Profilé aluminium Dos 33x20mm.



# ESCADOTE STANDARD EM ALUMÍNIO

STANDARD ALUMINUM LADDER | ESCALERA DE ALUMINIO ESTÁNDAR | ÉCHELLE STANDARD EN ALUMINIUM

## Características

- Disponível na versão de 2 a 8 degraus
- Fácil transporte e armazenamento
- Tampo superior antiderrapante em aço tratado com sistema de bloqueio
- Tacos de apoio em PVC antiderrapante
- Precintas de segurança antiabertura nas versões de 5 a 8 degraus
- Degrau antiderrapante com 80mm em alumínio com capas de proteção
- Perfil alumínio Frente 50x20mm
- Perfil alumínio Costas 33x20mm



	1	2	3	4	5	6	7	8	9
Steps	2	3	4	5	6	7	8		
Total Height (m)	1,070	1,320	1,560	1,810	2,050	2,300	2,540		
Top Step Height (m)	0,980	1,220	1,460	1,700	1,940	2,180	2,420		
Second Step Height (m)	0,385	0,620	0,860	1,130	1,340	1,570	1,795		
Height with Person (m)	2,385	2,620	2,860	3,130	3,340	3,570	3,795		
Width (m)	0,410	0,430	0,450	0,470	0,490	0,510	0,530		
Depth (m)	0,110	0,110	0,110	0,110	0,110	0,110	0,110		
Weight (KG)	2,00	2,70	3,00	3,90	4,60	5,00	5,50		
Reference (Ref)	A2000002	A2000003	A2000004	A2000005	A2000006	A2000007	A2000008		

## Translation | Traducción | Traduction

Available in version from 2 to 8 steps - Easy transport and storage - Anti-slip top top in treated steel with locking system - Anti-slip PVC support blocks - Anti-opening safety straps in versions from 5 to 8 steps - 80mm non-slip aluminum step with protective covers - Front aluminum profile 50x20mm - Back aluminum profile 33x20mm.

Disponível em versão de 2 a 8 passos - Fácil transporte e armazenamento - Standard Aluminum Stepladder - Tapa superior antiderrapante em aço tratado com sistema de bloqueio - Bloques de soporte de PVC antiderrapante - Correas de seguridad anti-abertura en versiones de 5 a 8 pasos - Peldaño de aluminio antiderrapante de 80 mm con cubiertas protectoras - Perfil de aluminio frontal 50x20mm - Perfil trasero de aluminio 33x20mm.

Échelle Standard en Aluminium - Disponible en version de 2 à 8 marches - Transport et stockage faciles - Dessus antidérapant en acier traité avec système de verrouillage - Blocs de support en PVC antidérapants - Sangles de sécurité anti-ouverture dans les versions de 5 à 8 marches - Marche en aluminium antidérapante de 80 mm avec couvercles de protection - Profilé avant en aluminium 50x20mm - Profilé arrière en aluminium 33x20mm.





# ESCADOTE BR50 EM ALUMÍNIO

BR 50 ALUMINIUM LADDER | ESCALERA DE ALUMINIO BR 50 |  
ÉCHELLE EN ALUMINIUM BR 50

## Características

- Disponível na versão de 2 a 8 degraus,
- Fácil transporte e armazenamento
- Tampo superior antiderrapante em aço tratado com sistema de bloqueio
- Equipado com bandeja porta ferramentas
- Tacos de apoio em PVC antiderrapante,
- Precintas de segurança antiabertura nas versões de 5 a 8 degraus,
- Degrau antiderrapante com 80mm em alumínio com capas de proteção
- Perfil alumínio Frente 50x20mm
- Perfil alumínio Costas 33x20mm

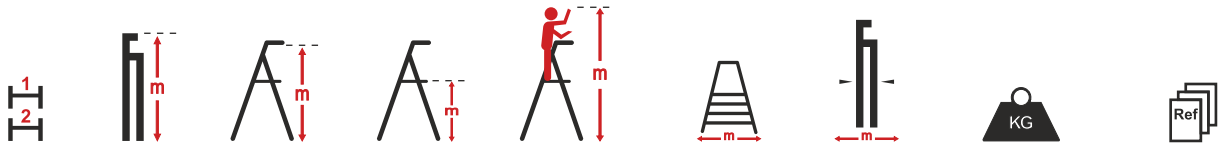
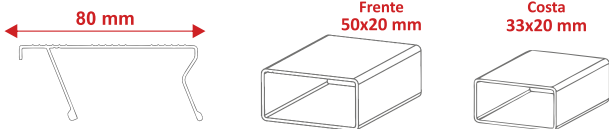
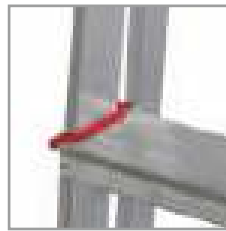

	1	2	3	4	5	6	7	8	9	10
Steps	2	3	4	5	6	7	8	9	10	11
Height (m)	1,110	1,350	1,600	1,850	2,120	2,350	2,600			
Width (m)	1,100	1,250	1,490	1,730	1,960	2,200	2,430			
Depth (m)	0,380	0,640	0,860	1,100	1,340	1,580	1,820			
Height (m)	2,380	2,640	2,860	2,100	2,340	2,570	2,820			
Width (m)	0,410	0,430	0,455	0,480	0,510	0,530	0,560			
Height (m)	0,110	0,110	0,110	0,110	0,110	0,110	0,110			
Weight (KG)	2,98	3,76	4,35	5,10	5,69	6,55	7,32			
Ref	A200022	A200033	A200024	A200025	A200026	A200027	A200028			

## Translation | Traducción | Traduction

BR50 Aluminum Stepladder - Available in version from 2 to 8 steps - Easy transport and storage - Anti-slip top top in treated steel with locking system - Anti-slip PVC support blocks - Anti-opening safety straps in versions from 5 to 8 steps - 80mm non-slip aluminum step with protective covers - Front aluminum profile 50x20mm - Back aluminum profile 33x20mm.

Escalera Tijera BR50 en Aluminio - Disponible en versión de 2 a 8 pasos - Fácil transporte y almacenamiento - Tapa superior antideslizante en acero tratado con sistema de bloqueo - Bloques de soporte de PVC antideslizante - Correas de seguridad anti-apertura en versiones de 5 a 8 pasos - Peldaño de aluminio antideslizante de 80 mm con cubiertas protectoras - Perfil de aluminio frontal 50x20mm - Perfil trasero de aluminio 33x20mm.

Escabeau BR50 en Aluminium - Disponible en version de 2 à 8 marches - Transport et stockage faciles - Dessus antidérapant en acier traité avec système de verrouillage - Blocs de support en PVC antidérapants - Sangles de sécurité anti-ouverture dans les versions de 5 à 8 marches - Marche en aluminium antidérapante de 80 mm avec couvercles de protection - Profilé avant en aluminium 50x20mm - Profilé arrière en aluminium 33x20mm.



# ESCADOTE R120 EM ALUMÍNIO

R120 ALUMINUM LADDER | ESCALERA DE ALUMINIO R120 |  
ÉCHELLE EN ALUMINIUM R120

## Características

- Disponível na versão de 2 a 8 degraus
- Fácil transporte e armazenamento
- Tampo superior antiderrapante em aço tratado com sistema de bloqueio
- Tacos de apoio em PVC antiderrapante,
- Precintas de segurança antiabertura nas versões de 5 a 8 degraus,
- Degrau antiderrapante extra largo com 120mm em alumínio com capas de proteção
- Perfil alumínio Frente 50x20mm
- Perfil alumínio Costas 40x20mm

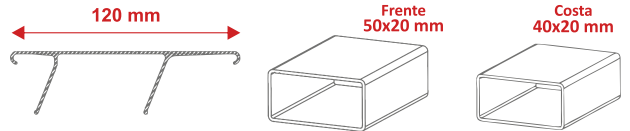
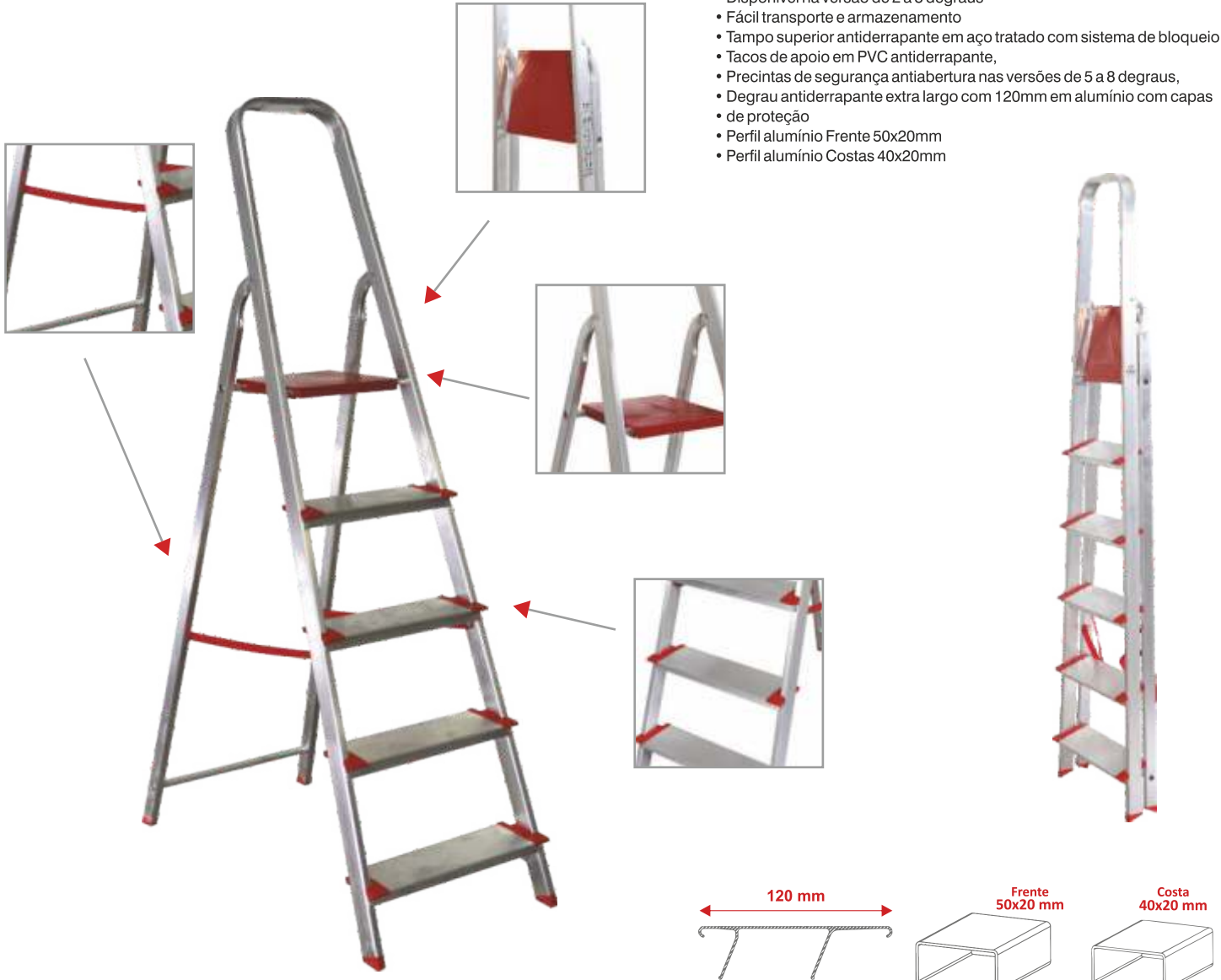

2	1,065	0,995	0,400	2,400	0,405	0,135	3,95	A2000202	
3	1,325	1,245	0,625	2,625	0,430	0,135	3,80	A2000203	
4	1,555	1,475	0,865	2,865	0,455	0,135	4,69	A2000204	
5	1,805	1,695	1,110	3,110	0,480	0,135	5,43	A2000205	
6	2,055	1,935	1,345	3,345	0,505	0,135	6,16	A2000206	
7	2,305	2,185	1,580	3,580	0,530	0,135	7,35	A2000207	
8	2,565	2,405	1,810	3,810	0,550	0,135	7,88	A2000208	

## Translation | Traducción | Traduction

R120 Aluminum Stepladder - Available in version from 2 to 8 steps - Easy transport and storage - Anti-slip top top in treated steel with locking system - Anti-slip PVC support blocks - Anti-opening safety straps in versions from 5 to 8 steps - Extra wide 120mm non-slip aluminum step with protective covers - Front aluminum profile 50x20mm - Back 40x20mm aluminum profile.

Escalera Tijera R120 en Aluminio - Disponible en versión de 2 a 8 pasos - Fácil transporte y almacenamiento - Tapa superior antideslizante en acero tratado con sistema de bloqueo - Bloques de soporte de PVC antideslizante - Correas de seguridad anti-apertura en versiones de 5 a 8 pasos - Escalón de aluminio antideslizante extra ancho de 120 mm con cubiertas protectoras - Perfil de aluminio frontal 50x20mm - Perfil de aluminio trasero de 40x20mm.

Escabeau R120 en Aluminium - Disponible en version de 2 à 8 marches - Transport et stockage faciles - Dessus antidérapant en acier traité avec système de verrouillage - Blocs de support PVC antidérapants - Sangles de sécurité anti-ouverture dans les versions de 5 à 8 marches - Marche en aluminium antidérapante extra large de 120 mm avec housses de protection - Profilé avant en aluminium 50x20mm - Profilé arrière en aluminium 40x20mm.



# ESCADOTE REFORÇADO EM ALUMÍNIO

REINFORCED ALUMINUM LADDER | ESCALERA DE ALUMINIO REFORZADO |  
ÉCHELLE EN ALUMINIUM RENFORCÉE

## Características

- Disponível na versão de 2 a 8 degraus
- Fácil transporte e armazenamento
- Tampo superior antiderrapante em aço tratado com sistema de bloqueio
- Tacos de apoio em PVC antiderrapante,
- Precintas de segurança antiabertura nas versões de 5 a 8 degraus,
- Degrau antiderrapante com 80mm em alumínio com capas de proteção
- Perfil alumínio Frente 50x20mm
- Perfil alumínio Costas 40x20mm

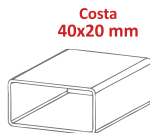
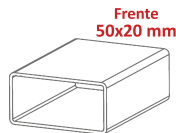
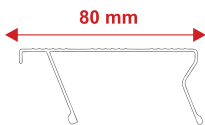

	1	2	3	4	5	6	7	8	9
2	1,065	0,995	0,400	2,400	0,405	0,120	3,45	A2000102	
3	1,325	1,245	0,625	2,625	0,430	0,120	3,69	A2000103	
4	1,555	1,475	0,865	2,865	0,455	0,120	4,86	A2000104	
5	1,805	1,695	1,110	3,110	0,480	0,120	5,17	A2000105	
6	2,055	1,935	1,345	3,345	0,505	0,120	5,86	A2000106	
7	2,305	2,185	1,580	3,580	0,530	0,120	6,55	A2000107	
8	2,565	2,405	1,810	3,810	0,550	0,120	7,23	A2000108	

## Translation | Traducción | Traduction

Strengthened Aluminum Stepladder - Available in version from 2 to 8 steps - Easy transport and storage - Anti-slip top top in treated steel with locking system - Anti-slip PVC support blocks - Anti-opening safety straps in versions from 5 to 8 steps - 80mm non-slip aluminum step with protective covers - Front aluminum profile 50x20mm - Back 40x20mm aluminum profile.

Escalera Tijera Reforzada en Aluminio - Disponible en versión de 2 a 8 pasos - Fácil transporte y almacenamiento - Tapa superior antideslizante en acero tratado con sistema de bloqueo - Bloques de soporte de PVC antideslizante - Correas de seguridad anti-apertura en versiones de 5 a 8 pasos - Peldaño de aluminio antideslizante de 80 mm con cubiertas protectoras - Perfil de aluminio frontal 50x20mm - Perfil de aluminio trasero de 40x20mm.

Escabeau Renforcé en Aluminium - Disponible en version de 2 à 8 marches - Transport et stockage faciles - Dessus antidérapant en acier traité avec système de verrouillage - Blocs de support PVC antidérapants - Sangles de sécurité anti-ouverture dans les versions de 5 à 8 marches - Marche en aluminium antidérapante de 80 mm avec couvercles de protection - Profilé avant en aluminium 50x20mm - Profilé arrière en aluminium 40x20mm.





# ESCADOTE POTENTE SOLDADO EM ALUMÍNIO

POWERFUL LADDER WELDED IN ALUMINUM | POTENTE ESCALERA SOLDADA EN ALUMINIO | ÉCHELLE PUISSANTE SOUDÉE EN ALUMINIUM

## Características

- Disponível na versão de 3 a 9 degraus
- Fácil transporte e armazenamento
- Estrutura sólida e resistente
- Tampo superior antiderrapante em aço tratado com sistema de bloqueio
- Equipado com bandeja porta-ferramentas
- Tacos de apoio em PVC antiderrapante com máxima robustez
- Precintas de segurança antiabertura,
- Degrau antiderrapante extra largo com 120mm em alumínio com capas de proteção
- Degraus com soldadura robotizada (ausência de rebites e parafusos)
- Articulações de alta segurança



**OPÇÃO CORRIMÃO**  
Handrail option  
Opción de pasamanos  
Option main courante

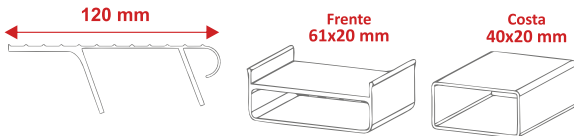
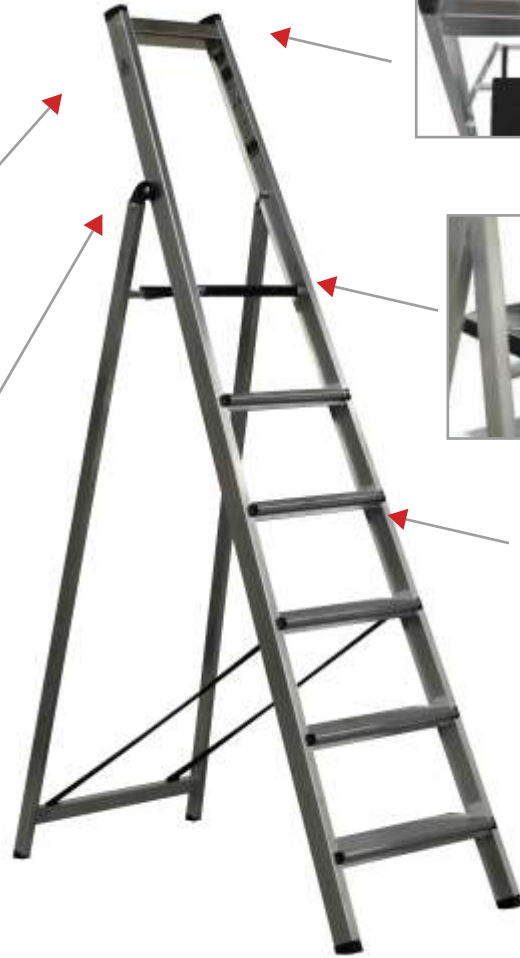
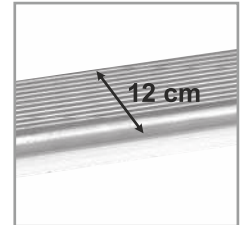

	1	2	3	4	5	6	7	8	9
3	1,360	1,240	0,630	2,630	0,430	0,120	5,36	A2000113	
4	1,670	1,520	0,910	2,910	0,460	0,120	6,40	A2000114	
5	1,860	1,740	1,110	3,110	0,490	0,120	7,36	A2000115	
6	2,110	1,970	1,340	3,340	0,515	0,120	8,50	A2000116	
7	2,360	2,200	1,570	3,570	0,540	0,120	9,73	A2000117	
8	2,610	2,430	1,800	3,800	0,565	0,120	10,90	A2000118	
9	2,860	2,660	2,030	4,030	0,590	0,120	11,10	A2000119	

## Translation | Traducción | Traduction

• Potente - Welded Aluminum Stepladder - Available in version from 3 to 9 steps - Easy transport and storage - Solid and resistant structure - Anti-slip top top in treated steel with locking system - Equipped with tool tray - Support blocks in non-slip PVC with maximum strength - Anti-opening safety straps - Extra wide 120mm non-slip aluminum step with protective covers - Robotized welding steps (absence of rivets and screws) - High security joints - Aluminum access handrail option - Front 61x20mm aluminum profile - Back 40x20mm aluminum profile.

• Potente - Escalera Tijera Soldada en Aluminio - Disponible en versión de 3 a 9 pasos - Fácil transporte y almacenamiento - Estructura sólida y resistente - Tapa superior antideslizante en acero tratado con sistema de bloqueo - Equipado con bandeja de herramientas - Bloques de soporte en PVC antideslizante de máxima resistencia - Correas de seguridad anti-apertura - Escalón de aluminio antideslizante extra ancho de 120 mm con cubiertas protectoras - Pasos de soldadura robotizados (ausencia de remaches y tornillos) - Juntas de alta seguridad - Opción de pasamanos de acceso de aluminio - Perfil de aluminio frontal 61x20mm - Perfil de aluminio trasero de 40x20mm.

• Potente - Escabeau Soudé en Aluminium - Disponible en version de 3 à 9 marches - Transport et stockage faciles - Structure solide et résistante - Dessus antidérapant en acier traité avec système de verrouillage - Équipé d'un plateau à outils - Blocs de support en PVC antidérapant avec une résistance maximale - Sangles de sécurité anti-ouverture - Marche en aluminium antidérapante extra large de 120 mm avec couvertures de protection - Étapes de soudage robotisées (absence de rivets et de vis) - Joints haute sécurité - Option de main courante d'accès en aluminium - Profilé avant en aluminium 61x20mm - Profilé arrière en aluminium 40x20mm.



Peso Máx. Soportado  
**150 kg**



**2 ANOS**  
WARRANTY



**SOLDADURA ROBOTIZADA**  
ROBOTIZED WELDING  
SOLDADURA ROBOTIZADA  
SOUDURE ROBOTISÉE

# ESCADOTE DUPLO DOMÉSTICO EM ALUMÍNIO

DOMESTIC DOUBLE LADDER IN ALUMINUM | ESCALERA DOBLE DOMÉSTICA EN ALUMINIO | ÉCHELLE DOMESTIQUE DOUBLE EN ALUMINIUM

## Características

- Disponível na versão de 2 a 6 degraus,
- Fácil transporte e armazenamento
- Tacos de apoio em PVC antiderrapante,
- Precintas de segurança antiabertura,
- Sistema segurança anti-fecho
- Degrau antiderrapante com 80mm em alumínio com capas de proteção
- Perfil alumínio 50x20mm



**OPÇÃO RODAS**  
wheel option  
opción de ruedas  
option roues

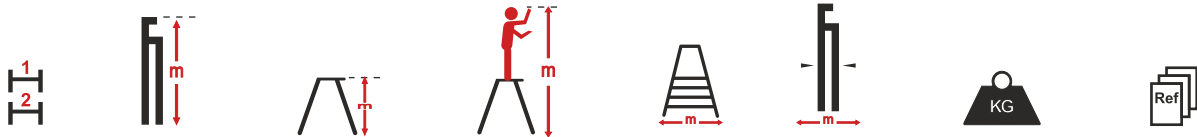
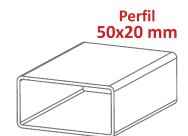
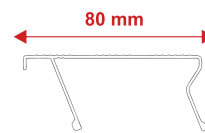

1 2	m	m	m	m	m	KG	Ref
2	0,440	0,400	2,400	0,420	0,160	2,45	A2001202
3	0,695	0,640	2,640	0,445	0,160	3,50	A2001203
4	0,940	0,860	2,860	0,470	0,160	4,50	A2001204
5	1,195	1,100	3,100	0,500	0,160	5,50	A2001205
6	1,445	1,340	3,340	0,525	0,160	6,00	A2001206

## Translation | Traducción | Traduction

Double Domestic Aluminum Stepladder - Available in - Available in 2 to 6 steps version - Easy transport and storage - Anti-slip PVC support blocks - Anti-opening safety straps - Anti-closing security system - 80mm non-slip aluminum step with protective covers - 50x20mm aluminum profile.

Escalera Doble Doméstica en Aluminio - Disponible en - Disponible en versión de 2 a 6 pasos - Fácil transporte y almacenamiento - Bloques de soporte de PVC antideslizante - Correas de seguridad anti-abertura - Sistema de seguridad anti-cierre - Peldaño de aluminio antideslizante de 80 mm con cubiertas protectoras - Perfil de aluminio de 50x20 mm.

Escabeau Double Domestique en Aluminium - Disponible en - Disponible en version 2 à 6 étapes - Transport et stockage faciles - Blocs de support PVC antidérapants - Sangles de sécurité anti-ouverture - Système de sécurité anti-fermeture - Marche en aluminium antidérapante de 80 mm avec couvercles de protection - Profilé aluminium 50x20mm.



Peso Máx. Soportado  
**150 kg**



WARRANTY  
**2 ANOS**  
\*\*\*



**EN131**\*



# ESCADOTE MÓVEL EM ALUMÍNIO

MOBILE ALUMINIUM LADDER | ESCALERA MÓVIL DE ALUMINIO |  
ÉCHELLE MOBILE EN ALUMINIUM

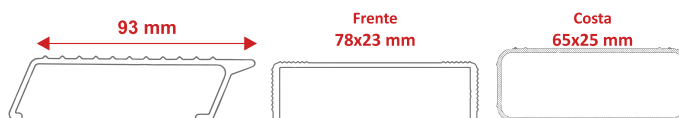

## Características

Modelo indicado para trabalhos que requerem a permanência do operador em altura por prolongados espaços de tempo.

- Disponível nas versões de 7 a 11 Degraus
- Base estabilizadora com tacos antiderrapantes
- Plataforma superior 40x50cm em chapa antiderrapante
- Guarda-corpos
- Bandeja porta-ferramentas
- Apoio manual com rodas para fácil manuseamento
- Degrau antiderrapante com 85mm
- Perfil dianteiro 78mm
- Perfil traseiro 65 mm
- Degraus soldados



Steps	Total Height (m)	Front Height (m)	Rear Height (m)	Working Height (m)	Width (m)	Weight (KG)	Ref
7	2,700	2,500	1,600	3,600	0,760	20,00	A800007
8	2,950	2,750	1,820	3,820	0,795	22,00	A800008
9	3,200	3,000	2,100	4,100	0,820	24,00	A800009
11	3,700	3,400	2,550	4,550	0,870	28,00	A800011

## Translation | Traducción | Traduction

Aluminium Mobile Stepladder - Model indicated for jobs that require the operator to remain at a height for long periods of time - Available in 7 to 11 Step versions - Stabilizing base with non-slip feet - 40x50cm top platform in non-slip sheet railings - Tool holder tray - Manual support with wheels for easy handling 85mm non-slip step - Front profile 78mm - Rear profile 65 mm - Welded steps.

Escalera Móvil en Aluminio - Modelo indicado para trabajos que requieren que el operario permanezca en altura durante largos periodos de tiempo - Disponible en versiones de 7 a 11 pasos - Base estabilizadora con tacos antideslizantes - Plataforma superior de 40x50cm en hoja antideslizante - Barandillas frontal - Bandeja portaherramientas - Soporte manual con ruedas para un fácil manejo - Peldaño antideslizante de 85 mm - Perfil frontal 78 mm - Perfil trasero 65 mm - Peldaños soldados.

Escabeau Mobile en Aluminium - Modèle indiqué pour les travaux qui nécessitent que l'opérateur reste en hauteur pendant de longues périodes - Disponible en versions 7 à 11 étapes - Base stabilisatrice avec patins antidérapants - Plateforme supérieure 40x50cm en feuille antidérapante - Garde-corps frontal - Plateau porte-outils - Support manuel avec roues pour une manipulation facile - Marche antidérapante de 85 mm - Profil avant 78mm - Profil arrière 65 mm - Marches soudées.



**SOLDADURA ROBOTIZADA**

ROBOTIZED WELDING  
SOLDADURA ROBOTIZADA  
SOUDURE ROBOTISÉE

# PLATAFORMA DE TRABALHO FLEX - ALUMÍNIO

FLEX WORK PLATFORM - ALUMINIUM | PLATAFORMA DE TRABAJO FLEX - ALUMINIO |  
PLATEFORME DE TRAVAIL FLEX - ALUMINIUM



## Características

Modelo indicado para trabalhos que requerem a permanência do operador em altura por prolongados espaços de tempo, devido à largura da plataforma e degrau.

Bastante resistente e fácil de transportar.

Grande estabilidade, robustez e segurança de trabalho.

Aconselha-se uma verificação antes de cada utilização

• Construída em tubo de alumínio: 65 x 25 mm, frente e costas

• Degrau antiderrapante com 86 x 24 mm em alumínio

• Degraus firmemente embutidos às secções laterais

• Base Estabilizadora com pés de borracha antiderrapantes

• Tacos borracha antiderrapante

• Capacidade máxima 150 kgs

• Porta Ferramentas

• Plataforma em chapa antiderrapante 510x410mm

• Guarda-corpos

• Barras estabilizadoras

• Disponível nas versões de 4 a 11 degraus

## UK - FEATURES

This model is recommended for work that requires the operator to remain at height for extended periods of time, due to the wide platform and step.

It is highly durable and easy to transport.

Excellent stability, robustness, and work safety.

Inspection is recommended before each use.

• Constructed of aluminum tubing: 65 x 25 mm, front and back

• Non-slip aluminum step with 86 x 24 mm

• Steps firmly embedded in the side sections

• Stabilizing base with non-slip rubber feet

• Non-slip rubber cleats

• Maximum capacity: 150 kg

• Tool holder

• Non-slip sheet metal platform 510 x 410 mm

• Guardrails

• Stabilizing bars

Available in 7 to 11 Step versions

## ES - CARACTERÍSTICAS

Este modelo se recomienda para trabajos que requieren que el operador permanezca en altura durante largos periodos de tiempo, gracias a su amplia plataforma y escalón.

Es muy resistente y fácil de transportar.

Excelente estabilidad, robustez y seguridad laboral.

Se recomienda inspeccionarlo antes de cada uso.

• Fabricado con tubos de aluminio: 65 x 25 mm (delanteros y traseros)

• Peldaño de aluminio antideslizante: 86 x 24 mm

• Peldaños firmemente integrados en las secciones laterales

• Base estabilizadora con patas de goma antideslizantes

• Tacos de goma antideslizantes

• Capacidad máxima: 150 kg

• Portaherramientas

• Plataforma de chapa antideslizante: 510 x 410 mm

• Barandillas

• Barras estabilizadoras

• Disponibles en versiones de 4 a 11 pasos

## FR - CARACTÉRISTIQUES

Ce modèle est recommandé pour les travaux nécessitant une position en hauteur prolongée, grâce à sa large plateforme et à sa marche-pied.

Il est très résistant et facile à transporter.

Excellente stabilité, robustesse et sécurité au travail.

Une inspection est recommandée avant chaque utilisation.

• Construction en tubes d'aluminium: 65 x 25 mm, avant et arrière

• Marche-pied antidérapant en aluminium de 86 x 24 mm

• Marches encastrées dans les sections latérales

• Base stabilisatrice avec pieds en caoutchouc antidérapants

• Crampons en caoutchouc antidérapants

• Capacité maximale: 150 kg

• Porte-outils

• Plateforme en feuille antidérapante de 510 x 410 mm



Degrau 86x24



Pefil lateral 65x25 frente e costa



4	2,27	0,99	2,99	0,2	0,5	0,65	A8000204	5606236852069
5	2,57	1,28	3,28	0,2	0,5	0,65	A8000205	5606236852113
6	2,87	1,55	3,55	0,2	0,5	0,65	A8000206	5606236852120
7	3,17	1,83	3,83	0,2	0,5	0,65	A8000207	5606236852076
8	3,47	2,1	4,1	0,2	0,5	0,65	A8000208	5606236852137
9	3,77	2,38	4,38	0,2	0,5	0,65	A8000209	5606236852083
10	4,07	2,65	4,65	0,2	0,5	0,65	A8000210	5606236852144
11	4,37	2,93	4,93	0,2	0,5	0,65	A8000211	5606236852090

em metros





# TABURETE EM ALUMÍNIO

ALUMINUM STOOL | TABURETE DE ALUMINIO |  
TABOURET EN ALUMINIUM

## Características

- Disponível na versão de 2 a 8 degraus,
- Fácil transporte e armazenamento
- Tampo superior antiderrapante em aço tratado com sistema de bloqueio
- Equipado com bandeja porta ferramentas
- Tacos de apoio em PVC antiderrapante,
- Precintas de segurança antiabertura nas versões de 5 a 8 degraus,
- Degrau antiderrapante com 80mm em alumínio com capas de proteção
- Perfil alumínio Frente 50x20mm
- Perfil alumínio Costas 33x20mm

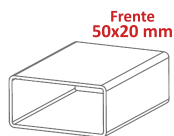
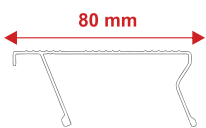

	1	2	3	4	5	6	7	8	9
TM2	2	0,620	0,44	2,43	0,440	0,13	2,00	A3009001	
TL3	3	0,810	0,51	2,67	0,515	0,13	2,40	A3009002	

## Translation | Traducción | Traduction

🇬🇧 R120 Aluminum Stepladder - Available in version from 2 to 8 steps - Easy transport and storage - Anti-slip top top in treated steel with locking system - Anti-slip PVC support blocks, - Anti-opening safety straps in versions from 5 to 8 steps - Extra wide 120mm non-slip aluminum step with protective covers - Front aluminum profile 50x20mm - Back 40x20mm aluminum profile.

🇵🇹 Escalera Tijera R120 en Aluminio - Disponible en versión de 2 a 8 pasos - Fácil transporte y almacenamiento - Tapa superior antiderrapante en acero tratado con sistema de bloqueo - Bloques de soporte de PVC antiderrapante - Correas de seguridad anti-apertura en versiones de 5 a 8 pasos - Escalón de aluminio antiderrapante extra ancho de 120 mm con cubiertas protectoras - Perfil de aluminio frontal 50x20mm - Perfil de aluminio trasero de 40x20mm.

🇫🇷 Escabeau R120 en Aluminium - Disponible en version de 2 à 8 marches - Transport et stockage faciles - Dessus antidérapant en acier traité avec système de verrouillage - Blocs de support PVC antidérapants - Sangles de sécurité anti-ouverture dans les versions de 5 à 8 marches - Marche en aluminium antidérapante extra large de 120 mm avec housses de protection - Profilé avant en aluminium 50x20mm - Profilé arrière en aluminium 40x20mm.



EN 14183-2

EN 14183-3

# ANDAIMES EM ALUMÍNIO

- Móvel
- Multiplus
- Semi profissional

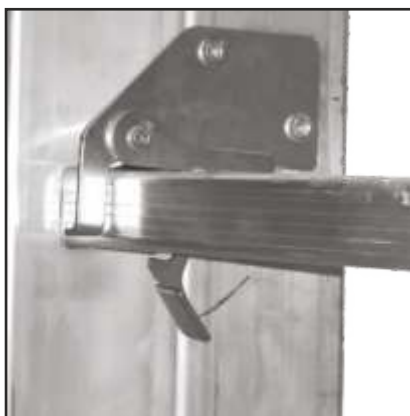
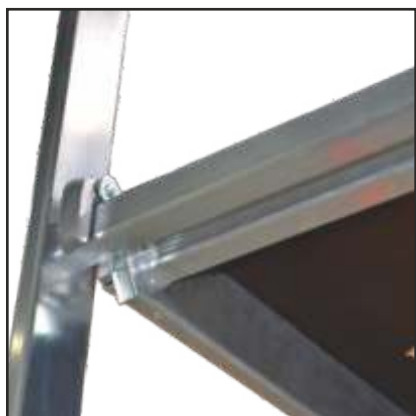

# ANDAIME MÓVEL EM ALUMÍNIO

MOBILE ALUMINUM SCAFFOLDING | ANDAMIO MÓVIL DE ALUMINIO | ÉCHAFAUDAGES MOBILES EN ALUMINIUM

## Características

- Disponível na versão de 2,00 e 2,5 metros
- Modelo desenhado para pequenos trabalhos de interior
- Este andaime é uma combinação de 2 escadas simples
- Possibilidade de utilizar as escadas em outras combinações (simples e dupla)
- Plataforma em folheado eucalipto
- Guarda corpos lateral
- Rodas para facilitar o manuseamento
- Montagem fácil e rápida
- Tacos de apoio em PVC antiderrapante
- Perfil 65x25
- Degrau secção 28x28mm com relevos antiderrapantes



### ANDAIME MÓVEL - Posição de trabalho

ADAIMO MÓVIL - Posicione de trabajo  
ECHAFAUDAGE MOBILE - Position de travail

### ESCALADA DUPLA - Posição de trabalho

ESCALERA COMBINADA 2 TRAMOS - Posicione de trabajo  
ÉCHELE TRANSFORMABLE 2 PLANS - Positions de travail

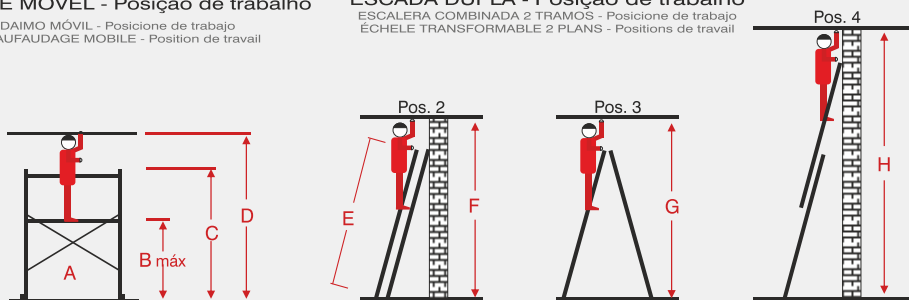

Referência Referencia Reference		A	B	C	D	E	F	G		H	Perfil Perfil Profile	Largura Ancho Largeur	
		mt	mt	mt	mt	mt	mt	mt		mt	65x25	0.41	KG
A5001101	2X7	1.23	0.90	2.00	3.00	2.00	3.00	3.00	75/65	4.25	65x25	0.41	13.25
A5001102	2X9	1.23	1.80	2.50	3.85	2.50	3.50	3.50	75/65	5.25	65x25	0.41	17.50

## Translation | Traducción | Traduction

Aluminum Mobile Scaffolds - Available in version 2,00 and 2,5 meters - Model designed for small interior work - This scaffold is a combination of 2 simple ladders - Possibility of using the stairs in other combinations (single and double) - Platform in eucalyptus veneer - Side guardrail - Wheels for easy handling - Easy and quick assembly - Anti-slip PVC support blocks - Profile 65x25 mm - Step 28x28mm section with non-slip reliefs.

Andamio Móvil en Aluminio - Disponible en las versiones de 2,00 y 2,5 metros - Modelo especialmente diseñado para pequeños trabajos de interior - Este andamio es una combinación de 2 escaleras simples - Posibilidad de utilizar las escaleras en otras combinaciones (simples y doble) - Plataforma en chapa de eucalipto - Barandilla lateral - Rodas para facilitar la manipulación - Montaje fácil y rápida - Tacos de apoyo en PVC antideslizante - Perfil 65x25 mm - Peldaño 28x28mm con relieves antideslizantes.

Échafaudage Mobile en Aluminium - Disponibles dans les versions de 2,00 et 2,5 mètres - Modèle spécialement destiné à être utilisé pour des petits travaux en intérieur - Cet échafaudage est une combinaison de 2 échelles simples - possibilité d'utiliser les échelles dans autres combinaisons - (simple et double) - Plateforme en placage d'eucalyptus - Garde-corps latéral - Roues pour faciliter la manipulation - Facile et rapide à assembler - Sabots d'appui en PVC antidérapantes - Profilé 65x25 mm - Marche 28x28mm avec reliefs antidérapantes.



# ANDAIME MULTIPLUS EM ALUMÍNIO

MULTIPLUS ALUMINIUM SCAFFOLDING | ANDAMIO DE ALUMINIO MULTIPLUS | ÉCHAFAUDAGES EN ALUMINIUM MULTIPLUS

## Características

Utilização: Bricolage

- Disponível na versão de 3,15 metros
- Modelo especialmente diseñado para trabajos en altura
- Este andaime é uma combinação de 2 escadas transformáveis e uma série de travessas que fazem a composição de uma estrutura estável e sólida
- Plataforma em choupo antiderrapante
- Rodas para facilitar o manuseamento
- Fácil e rápido de montar
- Possibilidade de ajustar à altura pretendida
- Tacos de apoio em PVC antiderrapante

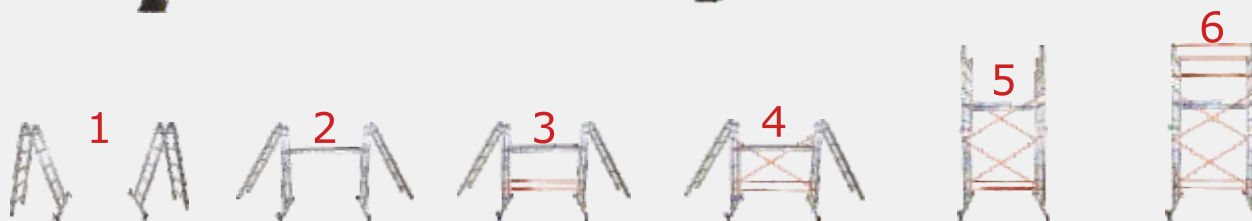
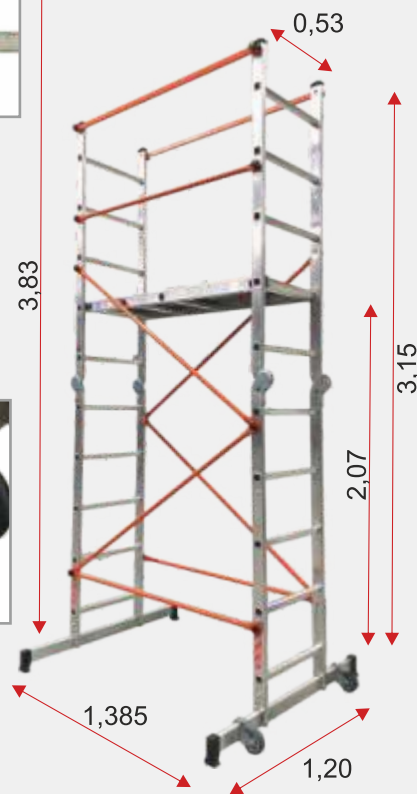
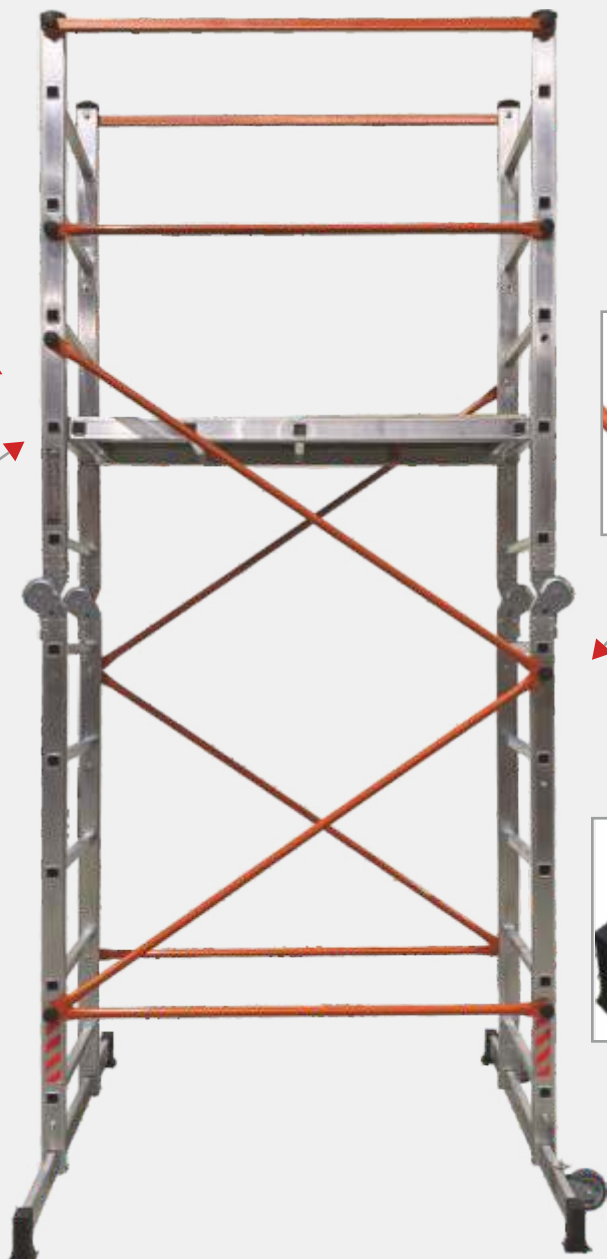

1



3,15



3,83



2,07



1,385



120



66x25



50,00



A5001315

## Translation | Traducción | Traduction

Aluminum Multiplus Scaffolds - Available in Use: DIY - Available on the version of 3,15 meters - Model designed for the use on works which require reaching higher levels - This scaffold consists of 2 transformable ladders combined with a series of stabilising bars which create a stable and solid structure - Poplar slip-resistant platform - Wheels in order to facilitate handling - Fast and easy assembly - Possibility of adjusting to the desired height - PVC slip-resistant feet.

Andamio Multiplus en Aluminio - Utilización: bricolaje - Disponible en la versión de 3,15 metros - Modelo especialmente diseñado para trabajos en altura - Este andamio es una combinación de 2 escaleras transformables y una serie de barras de seguridad que componen una estructura estable y sólida - Plataforma en álamo antideslizante - Rodas para facilitar la manipulación - Montaje fácil y rápido - Posibilidad de ajustar hasta la altura deseada - Tacos de apoyo en PVC antideslizante.

Échafaudage Multiplus en Aluminium - Usage: bricolage - Disponible dans la version de 3,15 mètres - Modèle spécialement destiné à être utilisé dans des travaux en hauteur - Cet échafaudage est une combinaison de 2 échelles transformables et plusieurs barres de stabilisation permettant ainsi une structure stable et solide - Plateforme en peuplier antidérapante - Roues pour faciliter la manipulation - Facile et rapide à assembler - Possibilité de régler à la hauteur souhaitée - Sabots d'appui en PVC antidérapantes.



Peso Máx. Soportado  
150 kg



2 ANOS



NF E85-200

# ANDAIME SEMI PROFISSIONAL EM ALUMÍNIO

SEMI PROFESSIONAL ALUMINUM SCAFFOLDING | ANDAMIO DE ALUMÍNIO SEMI PROFESIONAL | ÉCHAFAUDAGE SEMI-PROFESSIONNEL EN ALUMINIUM

## Características

Utilização: profissional e industrial

- Disponível na versão de 4 a 9 metros
- Modelo especialmente desenhado para trabalhos em altura
- Elevada segurança, plataforma com proteção antiqueda
- Alçapão para facilitar entrada na plataforma
- Facilidade de montagem
- Barras laterais estabilizadoras nas versões de 7 e 9 metros
- Rodas para facilitar o manuseamento
- Tacos de apoio em PVC antiderrapante
- Plataforma com e sem Alçapão
- Para versões do andaime de 4 metros e 5 metros usar 1 ou 2 plataformas.
- Para versões do andaime de 7 metros e 9 metros usar 2 ou 3 plataformas



	1	2	3	4	5	6	7	8	9
1	4,00	2,00	3,80	2,00	0,650	66x25	0,30	46,00	A5001140*
1	5,00	3,00	4,80	2,00	0,650	66x25	0,30	48,00	A5001150*
2	7,00	5,00	6,80	2,00	0,670	80x25	0,30	60,00	A5001170**
2	9,00	7,00	8,80	2,00	0,670	80x25	0,30	70,00	A5001190**

ACESSÓRIOS / ACCESSORIES / ACCESORIOS / ACCESSOIRES

\* BASE C/RODAS - BASE SIMPLES

BASE WITH WHEELS - SIMPLE BASE / BASE CON RUEDAS - BASE SIMPLE / BASE AVEC ROUES - BASE SIMPLE

\*\* SUPORTE RODAS C/ TRAVÃO - BASE SIMPLES - CONJUNTO ESCORAS LATERAIS

RUEDAS CON FRENO - BASE SIMPLE - MONTAJE MANCHAS LATERALES / ROUES AVEC FREIN - BASE SIMPLE - ASSEMBLAGE DE TACHES LATÉRALES



\*\* SEM QUADRA  
WITHOUT SQUARE  
SIN CUADRADO  
SANS CARRÉ

66x25

0,530

1,98

16,00

A6001101\*\*



\* COM QUADRA  
WITH SQUARE  
CON CUADRADO  
AVEC CARRÉ

66x25

0,530

1,98

17,50

A6001102\*

## Translation | Traducción | La traduction

SEMI PROFESSIONAL ALUMINUM Scaffolds - Use: Professional and industrial. - Available on the versions of 4 to 9 meters - Model specially designed to be used on works requiring reaching higher levels - High working safety - Platform with anti-fall protection - Trapdoor for easier access to the platform - Fast and easy assembly - Stabilising lateral bars on the versions of 7 and 9 meters - 2 wheels in order to facilitate handling - PVC slip-resistant feet. Platform with and without trapdoor - For scaffold versions of 4 meters and 5 meters use 1 or 2 platforms - For scaffold versions of 7 meters and 9 meters use 2 or 3 platforms.

Andamio Semi-Profesional Aluminio - Utilización: profesional e industrial - Disponible en las versiones de 4 hasta 9 metros - Modelo especialmente diseñado para trabajos en altura - Alta seguridad - Plataforma con protección contra la caída - Trampa para facilitar la entrada en la plataforma - Montaje fácil - Barras laterales estabilizadoras en las versiones de 7 hasta 9 metros - Rodas para facilitar la manipulación - Tacos de apoyo en PVC antiderrapante - Plataforma con y sin trampa - Por las versiones de andamio de 4 metros y 5 metros usar 1 o 2 plataformas - Por las versiones de andamio de 7 metros y 9 metros usar 2 o 3 plataformas.

Échafaudage Semi-Professionnel en Aluminium - Usage: Professionnel et industriel - Disponible dans les versions de 4 à 9 mètres - Modèle spécialement destiné à être utilisé dans des travaux en hauteur - Haute sécurité - Plateforme avec protection antichute - Trappe pour faciliter l'entrée dans la plateforme - Facile à assembler - Barres latérales de stabilisation dans les versions de 7 à 9 mètres - Roues pour faciliter la manipulation - Sabots d'appui en PVC antidérapantes - Plateforme avec et sans trappe - Pour les versions d'échafaudage de 4 mètres et 5 mètres utiliser 1 ou 2 plateformes - Pour les versions d'échafaudage 7 mètres et 9 mètres utiliser 2 ou 3 plateformes.



# TORRE ALUMAX

## Norma 1004-1

Tower Alumax | Torre Alumax | Echafaudage Alumax  
Standard 1004-1 | Estándar 1004-1 | Norme 1004-1

- **Uso intensivo profesional**  
*Intensive professional use | Uso profesional intensivo | Usage professionnel intensif*
- **Rápida montagem e desmontagem**  
*Quick assembly and disassembly | Montaje y desmontaje rápidos | Montage et démontage rapides*
- **Grande estabilidade e segurança**  
*High stability and safety | Alta estabilidad y seguridad | Stabilité et sécurité élevées*



**Modelos disponíveis:**  
*Available models | Modelos disponibles | Modèles disponibles*

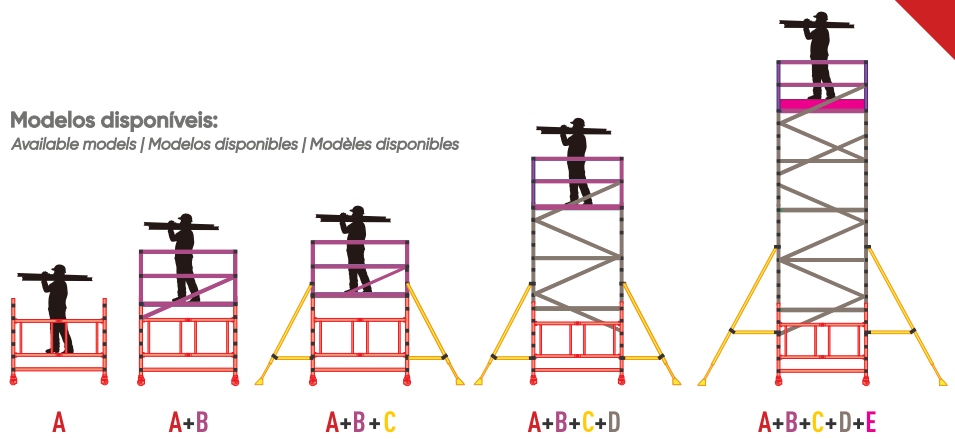

# TORRE ALUMAX PACK 1 (MÓDULO A) - NORMA 1004-1

TOWER ALUMAX PACK 1 (MODEL A) STANDARD 1004-1 | TORRE ALUMAX PACK 1 (MÓDULO A) ESTÁNDAR 1004-1 | ECHAUFDAUGE ALUMAX PACK 1 (MODÈLE A) NORME 1004-1

## Características

Features | Características | Caractéristiques

### ► Uso intensivo profesional

Intensive professional use | Uso profesional intensivo | Usage professionnel intensif

### ► Garantia: 5 Anos

Warranty: 5 years | Garantía: 5 años | Garantie : 5 ans

### ► As pranchas de madeira estão equipadas com alçapão de acesso pelo interior

The wooden boards are equipped with an interior access hatch | Los tablonces de madera están equipados con una trampilla de acceso interior. | Les panneaux en bois sont équipés d'une trappe d'accès intérieure

### ► Possibilidade de incorporar barras estabilizadoras que se fixam nos prumos.

Possibility of incorporating stabilizing bars that attach to the uprights. | Posibilidad de incorporar barras estabilizadoras que se fijan a los montantes. | Possibilité d'incorporer des barres stabilisatrices qui se fixent aux montants.

### ► As barras estabilizadoras permitem ajustar e adaptar em função da altura.

The stabilizing bars allow for height adjustment and adaptation | Las barras estabilizadoras permiten el ajuste de altura y la adaptación. | Les barres stabilisatrices permettent un réglage et une adaptation en fonction de la hauteur.

### ► Fácil e rápido na montagem e desmontagem.

Quick and easy assembly and disassembly | Montaje y desmontaje rápido y sencillo. | Montage et démontage faciles et rapides

### ► Rodas 125mm direcionais com travão.

125mm directional wheels with brakes | Ruedas direccionales de 125 mm con frenos | Roues directionnelles de 125 mm avec frein

### ► Montagem e desmontagem 100% segura para apenas 1 pessoa.

100% secure assembly and disassembly for one person | Montaje y desmontaje 100% seguro para una sola persona. | Montage et démontage 100 % sécurisés pour une seule personne.

### ► Modelo com grande estabilidade e segurança.

Model offering excellent stability and optimal safety | Modelo que ofrece una excelente estabilidad y una seguridad óptima. | Modèle offrant une excellente stabilité et sécurité optimale.

### ► Equipado com rodas deslizantes com travões de bloqueio.

Equipped with sliding wheels with brakes. | Equipado con ruedas deslizantes con frenos. | Équipé de roues coulissantes avec freins.

### ► O espaço útil das pranchas oferece conforto durante os trabalhos.

The usable panel space provides optimal comfort during work. | El espacio útil del panel proporciona una comodidad óptima durante el trabajo. | L'espace utile des panneaux offre un confort optimal pendant le travail.

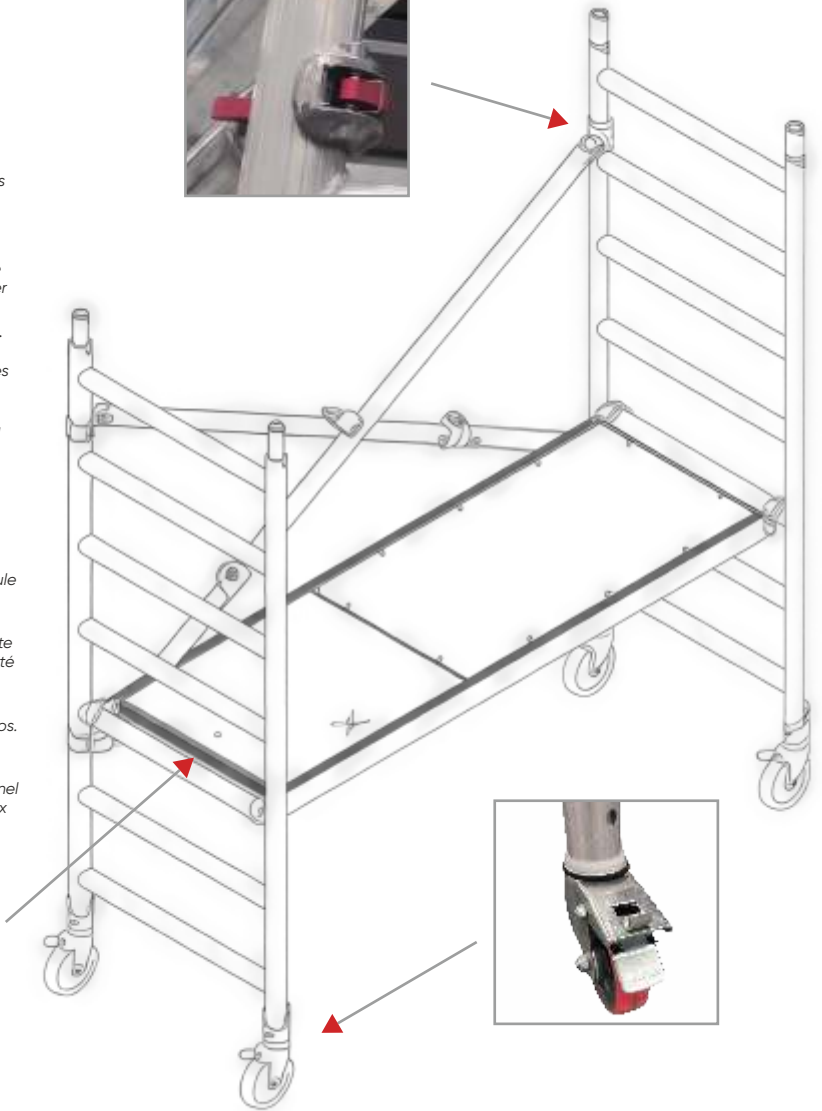

## Lista de peças

Parts list | Lista de piezas | Liste de pièces

Designação Description   Descripción   Désignation	Quantidade Quantity   Cantidad   Quantité
Perna Leg   Pierna   Jambe	2 Unidades 2 Units   2 Unidades   2 Unités
Travessa Crossbar   Travessaño   Traverse	1 Unidade 1 Unit   1 Unidade   1 Unité
Rodas Wheels   Ruedas   Roues	4 Unidades 4 Units   4 Unidades   4 Unités

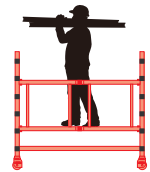

A



1



2,40



1,10



3,10



2,00



0,70



190x61



39,47



A7203100



## Translation | Traducción | Traduction

ALUMINIUM TOWER 2000X700 ALUMAX - Use: Intensive, Use: Level Floor, Warranty: 5 Years, Standard: EN1004-1/2004, With safety guards, Boards with interior access hatch, With removable 150mm skirting boards, 125mm directional wheels with brakes, Profiles with quick-release hooks, Welded aluminum frame with Ø 50x2 mm tube, Stabilizer bars with Ø 46.5x3 mm tube, Reinforced with internal connection with Ø 45x2 mm tube

TORRE DE ALUMINIO 2000X700 ALUMAX - Uso: Intensivo, Uso: Suelo plano, Garantía: 5 años, Norma: EN1004-1/2004, Con protecciones de seguridad, Paneles con trampilla de acceso interior, Con rodapiés extraíbles de 150 mm, Ruedas direccionales de 125 mm con freno, Perfiles con ganchos de liberación rápida, Marco de aluminio soldado con tubo de Ø 50 x 2 mm, Barras estabilizadoras con tubo de Ø 46,5 x 3 mm, Reforzado con conexión interna con tubo de Ø 45 x 2 mm

ECHAUFDAUGE 2000X700 ALUMAX - Usage : Intensif, Usage : Sol plat, Garantie : 5 ans, Norme : EN1004-1/2004, Avec protections de sécurité, Panneaux avec trappe d'accès intérieure, Avec plinthes amovibles de 150 mm, Roues directionnelles de 125 mm avec freins, Profils avec crochets à démontage rapide, Châssis en aluminium soudé avec tube Ø 50 x 2 mm, Barres stabilisatrices avec tube Ø 46,5 x 3 mm, Renforcé avec connexion interne avec tube Ø 45 x 2 mm



EN-1004-1 :2021

# TORRE ALUMAX PACK 2 (MÓDULO A+B) - NORMA 1004-1

TOWER ALUMAX PACK 2 (MODULE A+B) STANDARD 1004-1 | TORRE ALUMAX PACK 2 (MÓDULO A+B) ESTÁNDAR 1004-1 | ECHAUFUDAGE ALUMAX PACK 2 (MODULE A+B) NORME 1004-1

## Características

Features | Características | Caractéristiques

### ► Uso intensivo profesional

Intensive professional use | Uso profesional intensivo | Usage professionnel intensif

### ► Garantia: 5 Anos

Warranty: 5 years | Garantía: 5 años | Garantie : 5 ans

### ► As pranchas de madeira estão equipadas com alçapão de acesso pelo interior

The wooden boards are equipped with an interior access hatch | Los tablonos de madera están equipados con una trampilla de acceso interior. | Les panneaux en bois sont équipés d'une trappe d'accès intérieure

### ► Possibilidade de incorporar barras estabilizadoras que se fixam nos prumos.

Possibility of incorporating stabilizing bars that attach to the uprights. | Posibilidad de incorporar barras estabilizadoras que se fijan a los montantes. | Possibilité d'incorporer des barres stabilisatrices qui se fixent aux montants.

### ► As barras estabilizadoras permitem ajustar e adaptar em função da altura.

The stabilizing bars allow for height adjustment and adaptation | Las barras estabilizadoras permiten el ajuste de altura y la adaptación. | Les barres stabilisatrices permettent un réglage et une adaptation en fonction de la hauteur.

### ► Fácil e rápido na montagem e desmontagem.

Quick and easy assembly and disassembly | Montaje y desmontaje rápido y sencillo. | Montage et démontage faciles et rapides

### ► Rodas 125mm direcionais com travão.

125mm directional wheels with brakes | Ruedas direccionales de 125 mm con frenos | Roues directionnelles de 125 mm avec frein

### ► Montagem e desmontagem 100% segura para apenas 1 pessoa.

100% secure assembly and disassembly for one person | Montaje y desmontaje 100% seguro para una sola persona. | Montage et démontage 100 % sécurisés pour une seule personne.

### ► Modelo com grande estabilidade e segurança.

Model offering excellent stability and optimal safety | Modelo que ofrece una excelente estabilidad y una seguridad óptima. | Modèle offrant une excellente stabilité et sécurité optimale.

### ► Equipado com rodas deslizantes com travões de bloqueio.

Equipped with sliding wheels with brakes. | Equipado con ruedas deslizantes con frenos. | Équipé de roues coulissantes avec freins.

### ► O espaço útil das pranchas oferece conforto durante os trabalhos.

The usable panel space provides optimal comfort during work. | El espacio útil del panel proporciona una comodidad óptima durante el trabajo. | L'espace utile des panneaux offre un confort optimal pendant le travail.

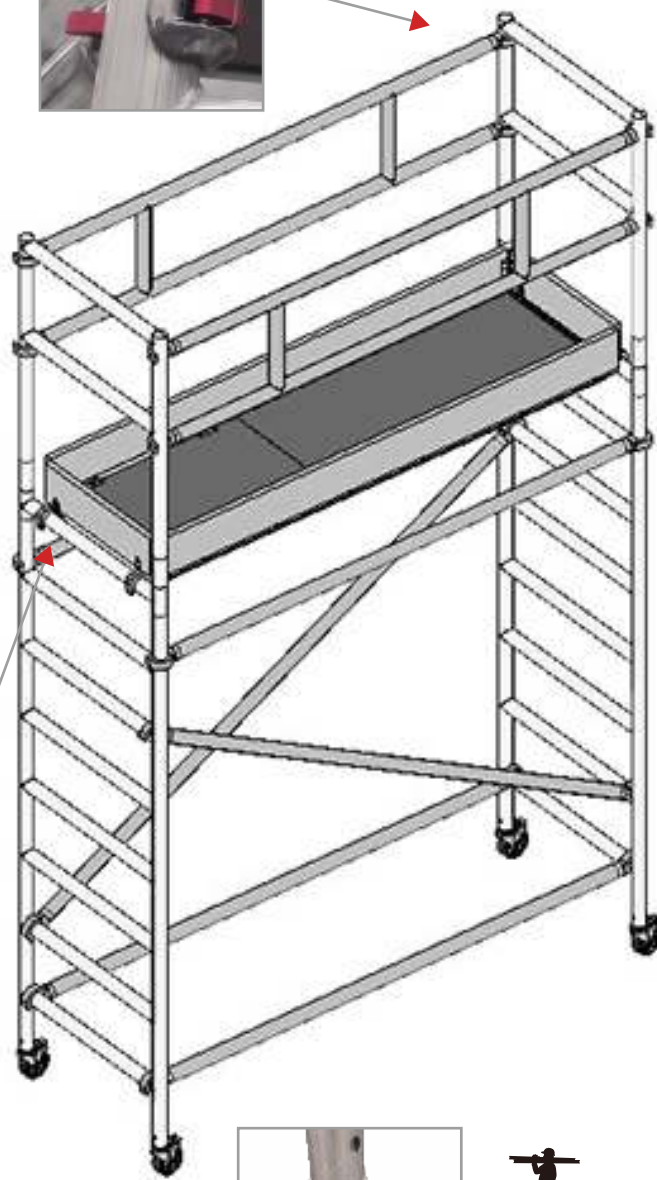

A+B

## Lista de peças

Parts list | Lista de piezas | Liste de pièces

Designação Description   Descripción   Designation	Quantidade Quantity   Cantidad   Quantité
<b>Perna</b> Leg   Pierna   Jambe	2 Unidades 2 Units   2 Unidades   2 Unités
<b>Travessa</b> Crossbar   Travesaño   Traverse	4 Unidade 4 Unit   4 Unidade   4 Unité
<b>Rodas</b> Wheels   Ruedas   Roues	4 Unidades 4 Units   4 Unidades   4 Unités
<b>Guarda corpos lateral</b> Side railing   Barandilla lateral   Garde corps latéral	2 Unidades 2 Units   2 Unidades   2 Unités
<b>Guarda corpos frontal</b> Front railing   Barandilla delantera   Garde corps frontal	2 Unidades 2 Units   2 Unidades   2 Unités



1



2,40



1,90



3,90



2,00



0,70



190x61



56,31



A7203900



### Alumínio

- Aluminium  
- Aluminio  
- Aluminium



### Ultra resistente

- Ultra resistant  
- Ultrarresistente  
- Ultra resistant



### Atualização de nível

- Upgrade level  
- Nivel de actualización  
- Amélioration de niveau



### Carga máxima de 200 kg/m<sup>2</sup>

- Maximum load of 200 kg/m<sup>2</sup>  
- Carga máxima de 200 kg/m<sup>2</sup>  
- Charge maximale de 200 kg/m<sup>2</sup>



### Uso profesional

- Professional use  
- Uso profesional  
- Usage professionnel

## Translation | Traducción | Traduction

ALUMINIUM TOWER 2000X700 ALUMAX - Use: Intensive, Use: Level Floor, Warranty: 5 Years, Standard: EN1004-1/2004, With safety guards, Boards with interior access hatch, With removable 150mm skirting boards, 125mm directional wheels with brakes, Profiles with quick-release hooks, Welded aluminum frame with Ø 50x2 mm tube, Stabilizer bars with Ø 46.5x3 mm tube, Reinforced with internal connection with Ø 45x2 mm tube

TORRE DE ALUMINIO 2000X700 ALUMAX - Uso: Intensivo, Uso: Suelo plano, Garantía: 5 años, Norma: EN1004-1/2004, Con protecciones de seguridad, Paneles con trampilla de acceso interior, Con rodapiés extraíbles de 150 mm, Ruedas direccionales de 125 mm con freno, Perfiles con ganchos de liberación rápida, Marco de aluminio soldado con tubo de Ø 50 x 2 mm, Barras estabilizadoras con tubo de Ø 46,5 x 3 mm, Reforzado con conexión interna con tubo de Ø 45 x 2 mm

ECHAUFUDAGE EN ALUMINIUM 2000X700 ALUMAX - Usage : Intensif, Usage : Sol plat, Garantie : 5 ans, Norme : EN1004-1/2004, Avec protections de sécurité, Panneaux avec trappe d'accès intérieure, Avec plinthes amovibles de 150 mm, Roues directionnelles de 125 mm avec freins, Profils avec crochets à démontage rapide, Châssis en aluminium soudé avec tube Ø 50 x 2 mm, Barres stabilisatrices avec tube Ø 46,5 x 3 mm, Renforcé avec connexion interne avec tube Ø 45 x 2 mm



EN-1004-1 :2021

# TORRE ALUMAX PACK 3 (MÓDULO A+B+C) - NORMA 1004-1

TOWER ALUMAX PACK 3 (MODULE A+B+C) STANDARD 1004-1 | TORRE ALUMAX PACK 3 (MÓDULO A+B+C) ESTÁNDAR 1004-1 | ECHAUFDAUGE ALUMAX PACK 3 (MODULE A+B+C) NORME 1004-1

## Características

Features | Características | Caractéristiques

- ▶ **Uso intensivo profesional**  
Intensive professional use | *Usage professionnel intensif*
- ▶ **Garantía: 5 Años**  
Warranty: 5 years | *Garantía: 5 años | Garantie: 5 ans*
- ▶ **As pranchas de madeira estão equipadas com alçapão de acesso pelo interior**  
The wooden boards are equipped with an interior access hatch | *Los tablonos de madera están equipados con una trampilla de acceso interior. | Les panneaux en bois sont équipés d'une trappe d'accès intérieure*
- ▶ **Possibilidade de incorporar barras estabilizadoras que se fixam nos prumos.**  
Possibility of incorporating stabilizing bars that attach to the uprights. | *Posibilidad de incorporar barras estabilizadoras que se fijan a los montantes. | Possibilité d'incorporer des barres stabilisatrices qui se fixent aux montants.*
- ▶ **As barras estabilizadoras permitem ajustar e adaptar em função da altura.**  
The stabilizing bars allow for height adjustment and adaptation | *Las barras estabilizadoras permiten el ajuste de altura y la adaptación. | Les barres stabilisatrices permettent un réglage et une adaptation en fonction de la hauteur.*
- ▶ **Fácil e rápido na montagem e desmontagem.**  
Quick and easy assembly and disassembly | *Montaje y desmontaje rápido y sencillo. | Montage et démontage faciles et rapides*
- ▶ **Rodas 125mm direcionais com travão.**  
125mm directional wheels with brakes | *Ruedas direccionales de 125 mm con frenos | Roues directionnelles de 125 mm avec frein*
- ▶ **Montagem e desmontagem 100% segura para apenas 1 pessoa.**  
100% secure assembly and disassembly for one person | *Montaje y desmontaje 100% seguro para una sola persona. | Montage et démontage 100 % sécurisés pour une seule personne.*
- ▶ **Modelo com grande estabilidade e segurança.**  
Model offering excellent stability and optimal safety | *Modelo que ofrece una excelente estabilidad y una seguridad óptima. | Modèle offrant une excellente stabilité et sécurité optimale.*
- ▶ **Equipado com rodas deslizantes com travões de bloqueio.**  
Equipped with sliding wheels with brakes. | *Equipado con ruedas deslizantes con frenos. | Équipé de roues coulissantes avec freins.*
- ▶ **O espaço útil das pranchas oferece conforto durante os trabalhos.**  
The usable panel space provides optimal comfort during work. | *El espacio útil del panel proporciona una comodidad óptima durante el trabajo. | L'espace utile des panneaux offre un confort optimal pendant le travail.*

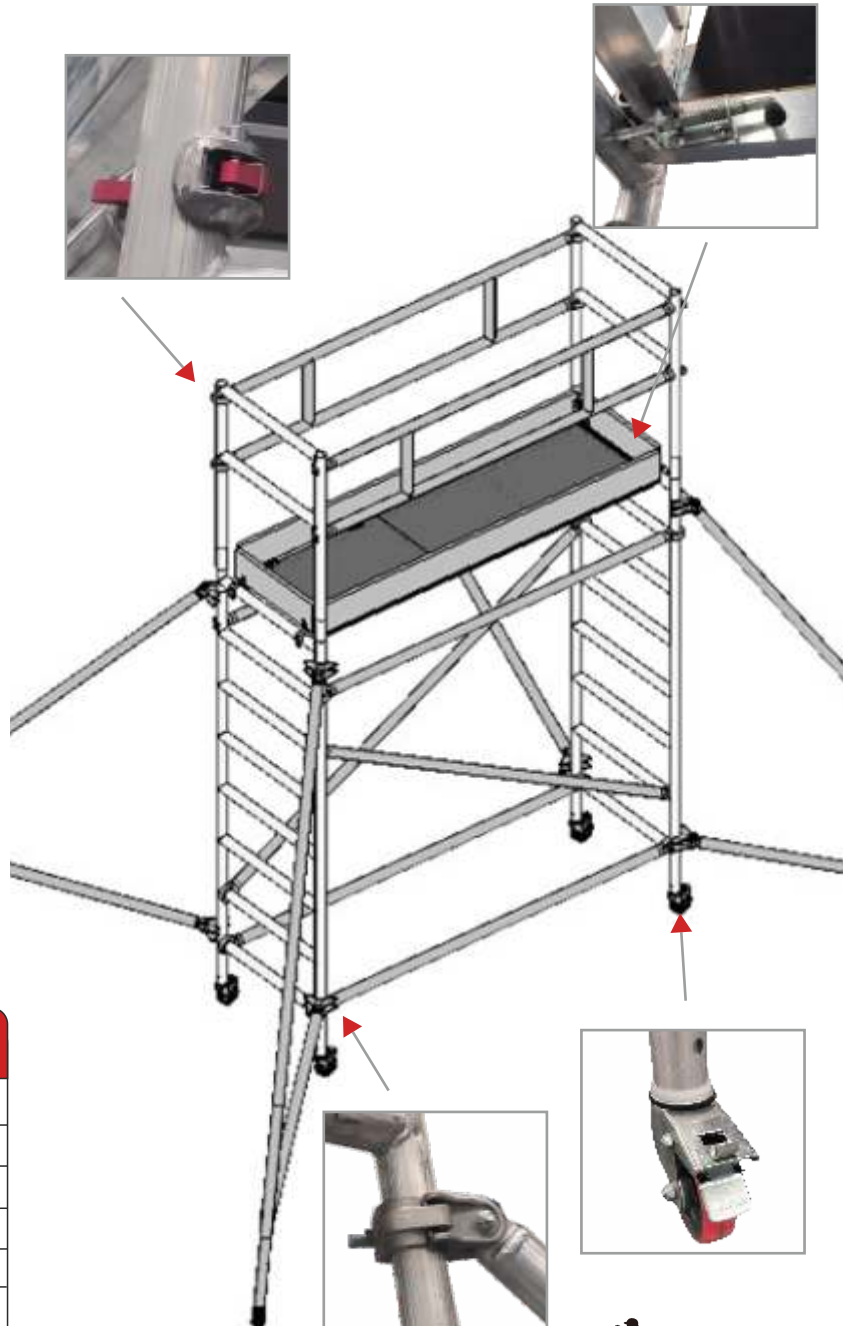

## Lista de peças

Parts list | *Lista de piezas* | *Liste de pièces*

Designação <i>Description   Descripción   Désignation</i>	Quantidade <i>Quantity   Cantidad   Quantité</i>
<b>Perna</b> <i>Leg   Pierna   Jambe</i>	2 Unidades <i>2 Units   2 Unidades   2 Unités</i>
<b>Travessa</b> <i>Crossbar   Travesaño   Traverse</i>	4 Unidade <i>4 Unit   4 Unidades   4 Unité</i>
<b>Rodas</b> <i>Wheels   Ruedas   Roues</i>	4 Unidades <i>4 Units   4 Unidades   4 Unités</i>
<b>Diagonal</b> <i>Diagonal   Diagonal   Diagonale</i>	2 Unidades <i>2 Units   2 Unidades   2 Unités</i>
<b>Estabilizador</b> <i>Stabilizer   Estabilizador   Stabilisateur</i>	4 Unidades <i>4 Units   4 Unidades   4 Unités</i>
<b>Prancha</b> <i>Board   Junta   Planche</i>	1 Unidades <i>1 Units   1 Unidades   1 Unités</i>
<b>Rodapé</b> <i>Skirting Board   Rodapié   Plinthe</i>	1 Unidades <i>1 Units   1 Unidades   1 Unités</i>
<b>Guarda corpos lateral</b> <i>Side railing   Barandilla lateral   Garde corps latéral</i>	2 Unidades <i>2 Units   2 Unidades   2 Unités</i>
<b>Guarda corpos frontal</b> <i>Front railing   Barandilla delantera   Garde corps frontal</i>	2 Unidades <i>2 Units   2 Unidades   2 Unités</i>

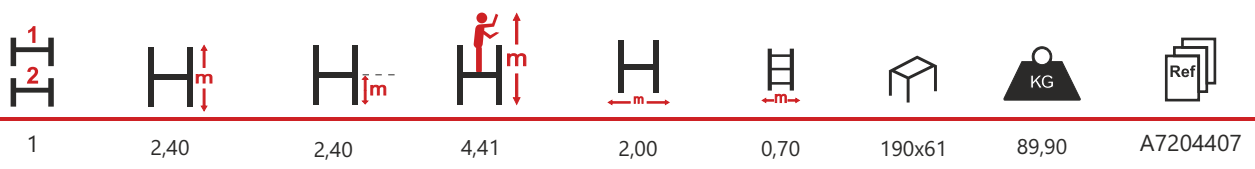
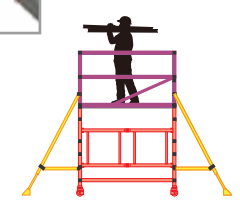

- Alumínio** - Aluminium - *Aluminium*
- Ultra resistente** - Ultra resistant - *Ultraresistente* - *Ultra resistant*
- Atualização de nível** - Upgrade level - *Nivel de actualización* - *Amélioration de niveau*
- Carga máxima de 200 kg/m<sup>2</sup>** - Maximum load of 200 kg/m<sup>2</sup> - *Carga máxima de 200 kg/m<sup>2</sup>* - *Charge maximale de 200 kg/m<sup>2</sup>*
- Uso profissional** - Professional use - *Uso profesional* - *Usage professionnel*

## Translation | Traducción | Traduction

**EN 1004-1 :2021**

ALUMINIUM TOWER 2000X700 ALUMAX - *Use: Intensive, Use: Level Floor, Warranty: 5 Years, Standard: EN1004-1/2004, With safety guards, Boards with interior access hatch, With removable 150mm skirting boards, 125mm directional wheels with brakes, Profiles with quick-release hooks, Welded aluminum frame with Ø 50x2 mm tube, Stabilizer bars with Ø 46.5x3 mm tube, Reinforced with internal connection with Ø 45x2 mm tube*

TORRE DE ALUMÍNIO 2000X700 ALUMAX - *Uso: Intensivo, Uso: Suelo plano, Garantía: 5 años, Norma: EN1004-1/2004, Con protecciones de seguridad, Paneles con trampilla de acceso interior, Con rodapiés extraíbles de 150 mm, Ruedas direccionales de 125 mm con freno, Perfiles con ganchos de liberación rápida, Marco de aluminio soldado con tubo de Ø 50 x 2 mm, Barras estabilizadoras con tubo de Ø 46,5 x 3 mm, Reforzado con conexión interna con tubo de Ø 45 x 2 mm*

ECHAUFDAUGE EN ALUMINIUM 2000X700 ALUMAX - *Usage: Intensif, Usage: Sol plat, Garantie: 5 ans, Norme: EN1004-1/2004, Avec protections de sécurité, Panneaux avec trappe d'accès intérieure, Avec plinthes amovibles de 150 mm, Roues directionnelles de 125 mm avec freins, Profils avec crochets à démontage rapide, Châssis en aluminium soudé avec tube Ø 50 x 2 mm, Barres stabilisatrices avec tube Ø 46,5 x 3 mm, Renforcé avec connexion interne avec tube Ø 45 x 2 mm*

150 kg | 2 ANOS | EN-1004-1 :2021

# TORRE ALUMAX PACK 4 (MÓDULO A+B+C+D) - NORMA 1004-1

TOWER ALUMAX PACK 4 (MODULE A+B+C+D) STANDARD 1004-1 | TORRE ALUMAX PACK 4 (MÓDULO A+B+C+D) ESTÁNDAR 1004-1 | ECHAUFDAUGE ALUMAX PACK 4 (MODULE A+B+C+D) NORME 1004-1

## Características

Features | Características | Caractéristiques

- **Uso intensivo profesional**  
Intensive professional use | Uso profesional intensivo | Usage professionnel intensif
- **Garantía: 5 Años**  
Warranty: 5 years | Garantia: 5 años | Garantie : 5 ans
- **As pranchas de madeira estão equipadas com alçapão de acesso pelo interior**  
The wooden boards are equipped with an interior access hatch | Los tablonos de madera están equipados con una trampilla de acceso interior. | Les panneaux en bois sont équipés d'une trappe d'accès intérieure
- **Possibilidade de incorporar barras estabilizadoras que se fixam nos prumos.**  
Possibility of incorporating stabilizing bars that attach to the uprights. | Posibilidad de incorporar barras estabilizadoras que se fijan a los montantes. | Possibilité d'incorporer des barres stabilisatrices qui se fixent aux montants.
- **As barras estabilizadoras permitem ajustar e adaptar em função da altura.**  
The stabilizing bars allow for height adjustment and adaptation | Las barras estabilizadoras permiten el ajuste de altura y la adaptación. | Les barres stabilisatrices permettent un réglage et une adaptation en fonction de la hauteur.
- **Fácil e rápido na montagem e desmontagem.**  
Quick and easy assembly and disassembly | Montaje y desmontaje rápido y sencillo. | Montage et démontage faciles et rapides
- **Rodas 125mm direcionais com travão.**  
125mm directional wheels with brakes | Ruedas direccionales de 125 mm con frenos | Roues directionnelles de 125 mm avec frein
- **Montagem e desmontagem 100% segura para apenas 1 pessoa.**  
100% secure assembly and disassembly for one person | Montaje y desmontaje 100% seguro para una sola persona. | Montage et démontage 100 % sécurisés pour une seule personne.
- **Modelo com grande estabilidade e segurança.**  
Model offering excellent stability and optimal safety | Modelo que ofrece una excelente estabilidad y una seguridad óptima. | Modèle offrant une excellente stabilité et sécurité optimale.
- **Equipado com rodas deslizantes com travões de bloqueio.**  
Equipped with sliding wheels with brakes. | Equipado con ruedas deslizantes con frenos. | Équipé de roues coulissantes avec freins.
- **O espaço útil das pranchas oferece conforto durante os trabalhos.**  
The usable panel space provides optimal comfort during work. | El espacio útil del panel proporciona una comodidad óptima durante el trabajo. | L'espace utile des panneaux offre un confort optimal pendant le travail.

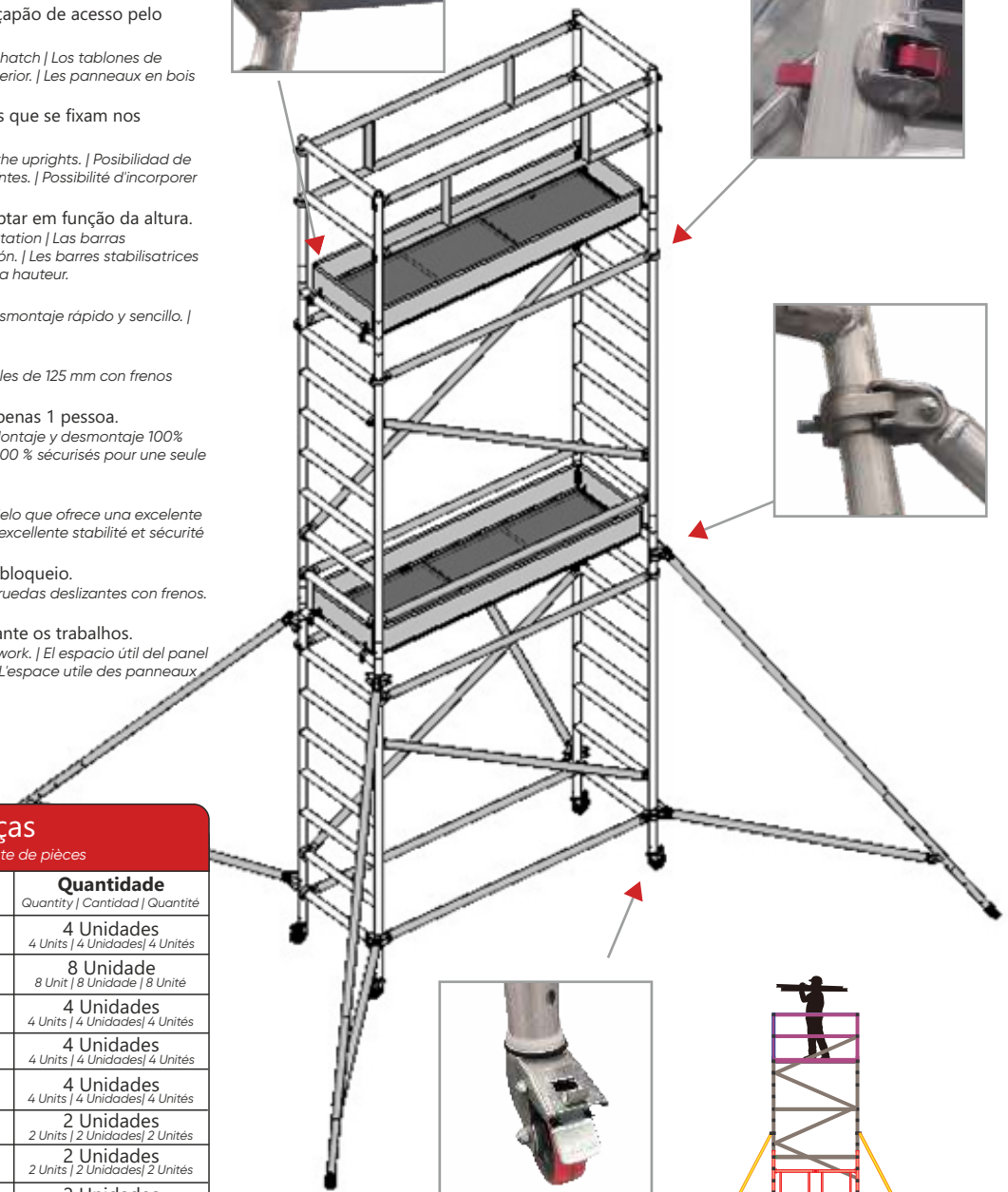

## Lista de peças

Parts list | Lista de piezas | Liste de pièces

Designação Description   Descripción   Désignation	Quantidade Quantity   Cantidad   Quantité
Perna Leg   Pierna   Jambe	4 Unidades 4 Units   4 Unidades   4 Unités
Travessa Crossbar   Travesaño   Traverse	8 Unidade 8 Unit   8 Unidade   8 Unité
Rodas Wheels   Ruedas   Roues	4 Unidades 4 Units   4 Unidades   4 Unités
Diagonal Diagonal   Diagonal   Diagonale	4 Unidades 4 Units   4 Unidades   4 Unités
Estabilizador Stabilizer   Estabilizador   Stabilisateur	4 Unidades 4 Units   4 Unidades   4 Unités
Prancha Board   Junta   Planche	2 Unidades 2 Units   2 Unidades   2 Unités
Rodapé Skirting Board   Rodapié   Plinthe	2 Unidades 2 Units   2 Unidades   2 Unités
Guarda corpos lateral Side railing   Barandilla lateral   Garde corps latéral	2 Unidades 2 Units   2 Unidades   2 Unités
Guarda corpos frontal Front railing   Barandilla delantera   Garde corps frontal	2 Unidades 2 Units   2 Unidades   2 Unités

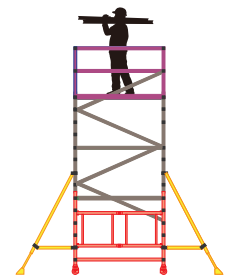

A+B+C+D



2



2,40



4,64



6,65



2,00



0,70



190x61



129,75



A7206647



**Alumínio**

- Aluminium  
- Aluminium  
- Aluminium



**Ultra resistente**

- Ultra resistant  
- Ultrarresistente  
- Ultra resistant



**Atualização de nível**

- Upgrade level  
- Nivel de actualización  
- Amélioration de niveau



**Carga máxima de 200 kg/m²**

- Maximum load of 200 kg/m²  
- Carga máxima de 200 kg/m²  
- Charge maximale de 200 kg/m²



**Uso profissional**

- Professional use  
- Uso profesional  
- Usage professionnel

## Translation | Traducción | Traduction

ALUMINIUM TOWER 2000X700 ALUMAX - Use: Intensive, Use: Level Floor, Warranty: 5 Years, Standard: EN1004-1/2004, With safety guards, Boards with interior access hatch, With removable 150mm skirting boards, 125mm directional wheels with brakes, Profiles with quick-release hooks, Welded aluminum frame with Ø 50x2 mm tube, Stabilizer bars with Ø 46.5x3 mm tube, Reinforced with internal connection with Ø 45x2 mm tube

TORRE DE ALUMINIO 2000X700 ALUMAX - Uso: Intensivo, Uso: Suelo plano, Garantía: 5 años, Norma: EN1004-1/2004, Con protecciones de seguridad, Paneles con trampilla de acceso interior, Con rodapiés extraíbles de 150 mm, Ruedas direccionales de 125 mm con freno, Perfiles con ganchos de liberación rápida, Marco de aluminio soldado con tubo de Ø 50 x 2 mm, Barras estabilizadoras con tubo de Ø 46,5 x 3 mm, Reforzado con conexión interna con tubo de Ø 45 x 2 mm

ECHAUFDAUGE EN ALUMINIUM 2000X700 ALUMAX - Usage : Intensif, Usage : Sol plat, Garantie : 5 ans, Norme : EN1004-1/2004, Avec protections de sécurité, Panneaux avec trappe d'accès intérieure, Avec plinthes amovibles de 150 mm, Roues directionnelles de 125 mm avec freins, Profils avec crochets à démontage rapide, Châssis en aluminium soudé avec tube Ø 50 x 2 mm, Barres stabilisatrices avec tube Ø 46,5 x 3 mm, Renforcé avec connexion interne avec tube Ø 45 x 2 mm



Peso Máx. Soportado  
150 kg



EN-1004-1 :2021

# TORRE ALUMAX PACK 5 (MÓDULO A+B+C+D+E) - NORMA 1004-1

TOWER ALUMAX PACK 5 (MODULE A+B+C+D+E) STANDARD 1004-1 | TORRE ALUMAX PACK 5 (MÓDULO A+B+C+D+E) ESTÁNDAR 1004-1 | ECHAUFDAUGE ALUMAX PACK 5 (MODULE A+B+C+D+E) NORME 1004-1

## Características

Features | Características | Caractéristiques

### ► Uso intensivo profesional

Intensive professional use | Uso profesional intensivo | Usage professionnel intensif

### ► Garantia: 5 Anos

Warranty: 5 years | Garantía: 5 años | Garantie: 5 ans

### ► As pranchas de madeira estão equipadas com alçapão de acesso pelo interior

The wooden boards are equipped with an interior access hatch | Los tablonos de madera están equipados con una trampilla de acceso interior. | Les panneaux en bois sont équipés d'une trappe d'accès intérieure

### ► Possibilidade de incorporar barras estabilizadoras que se fixam nos prumos.

Possibility of incorporating stabilizing bars that attach to the uprights. | Posibilidad de incorporar barras estabilizadoras que se fijan a los montantes. | Possibilité d'incorporer des barres stabilisatrices qui se fixent aux montants.

### ► As barras estabilizadoras permitem ajustar e adaptar em função da altura.

The stabilizing bars allow for height adjustment and adaptation | Las barras estabilizadoras permiten el ajuste de altura y la adaptación. | Les barres stabilisatrices permettent un réglage et une adaptation en fonction de la hauteur.

### ► Fácil e rápido na montagem e desmontagem.

Quick and easy assembly and disassembly | Montaje y desmontaje rápido y sencillo. | Montage et démontage faciles et rapides

### ► Rodas 125mm direcionais com travão.

125mm directional wheels with brakes | Ruedas direccionales de 125 mm con frenos | Roues directionnelles de 125 mm avec frein

### ► Montagem e desmontagem 100% segura para apenas 1 pessoa.

100% secure assembly and disassembly for one person | Montaje y desmontaje 100% seguro para una sola persona. | Montage et démontage 100 % sécurisés pour une seule personne.

### ► Modelo com grande estabilidade e segurança.

Model offering excellent stability and optimal safety | Modelo que ofrece una excelente estabilidad y una seguridad óptima. | Modèle offrant une excellente stabilité et sécurité optimale.

### ► Equipado com rodas deslizantes com travões de bloqueio.

Equipped with sliding wheels with brakes. | Equipado con ruedas deslizantes con frenos. | Équipé de roues coulissantes avec freins.

### ► O espaço útil das pranchas oferece conforto durante os trabalhos.

The usable panel space provides optimal comfort during work. | El espacio útil del panel proporciona una comodidad óptima durante el trabajo. | L'espace utile des panneaux offre un confort optimal pendant le travail.

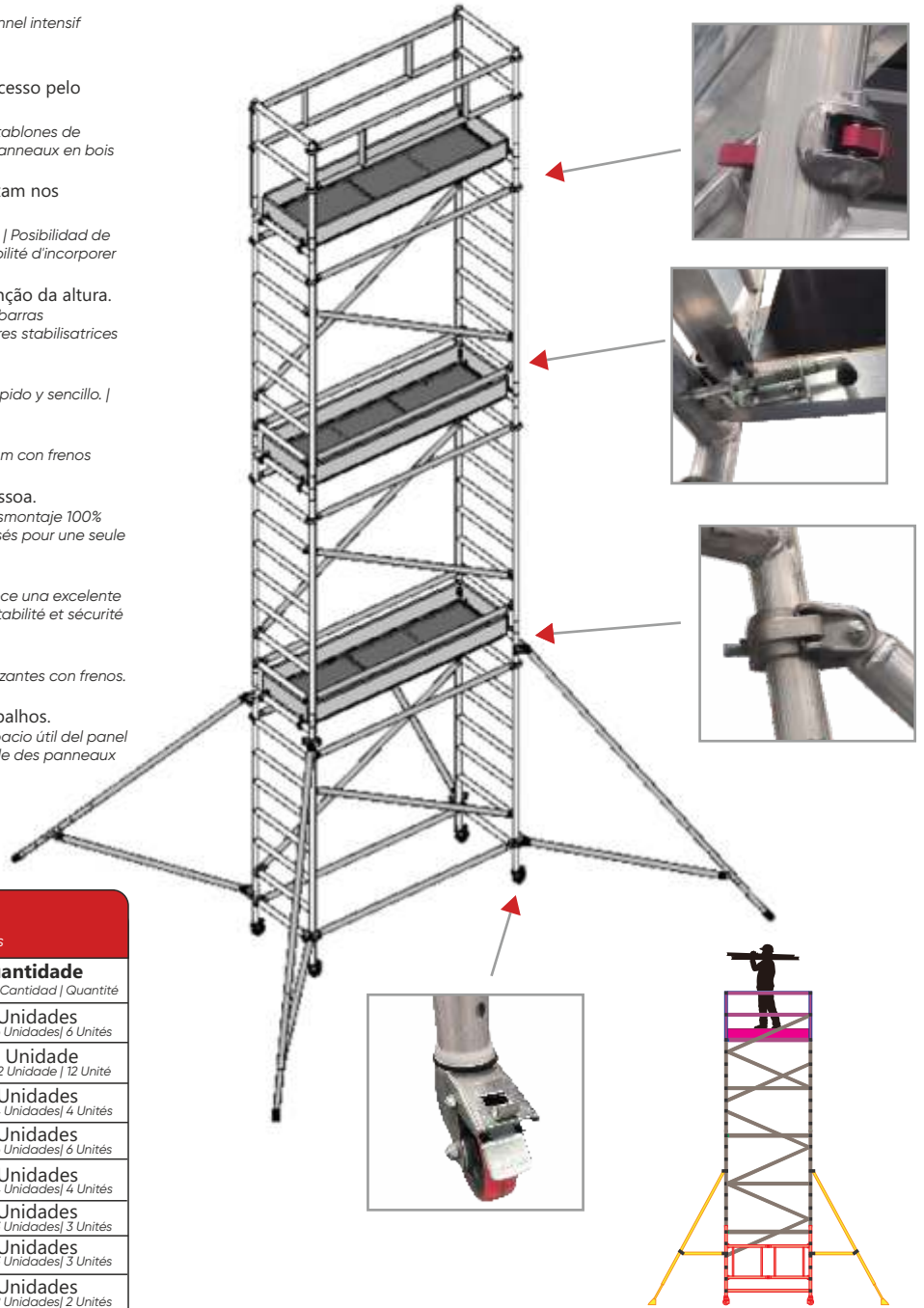

## Lista de peças

Parts list | Lista de piezas | Liste de pièces

Designação Description   Descripción   Désignation	Quantidade Quantity   Cantidad   Quantité
Perna Leg   Pierna   Jambe	6 Unidades 6 Units   6 Unidades   6 Unités
Travessa Crossbar   Travesaño   Traverse	12 Unidade 12 Unit   12 Unidade   12 Unité
Rodas Wheels   Ruedas   Roues	4 Unidades 4 Units   4 Unidades   4 Unités
Diagonal Diagonal   Diagonal   Diagonale	6 Unidades 6 Units   6 Unidades   6 Unités
Estabilizador Stabilizer   Estabilizador   Stabilisateur	4 Unidades 4 Units   4 Unidades   4 Unités
Prancha Board   Junta   Planche	3 Unidades 3 Units   3 Unidades   3 Unités
Rodapé Skirting Board   Rodapié   Plinthe	3 Unidades 3 Units   3 Unidades   3 Unités
Guarda corpos lateral Side railing   Barandilla lateral   Garde corps latéral	2 Unidades 2 Units   2 Unidades   2 Unités
Guarda corpos frontal Front railing   Barandilla delantera   Garde corps frontal	2 Unidades 2 Units   2 Unidades   2 Unités



3



2,40



6,88



8,89



2,00



0,70



190x61



169,80



A7208887



### Alumínio

- Aluminium  
- Aluminio  
- Aluminium



### Ultra resistente

- Ultra resistant  
- Ultrarresistente  
- Ultra resistant



### Atualização de nível

- Upgrade level  
- Nivel de actualización  
- Amélioration de niveau



### Carga máxima de 200 kg/m<sup>2</sup>

- Maximum load of 200 kg/m<sup>2</sup>  
- Carga máxima de 200 kg/m<sup>2</sup>  
- Charge maximale de 200 kg/m<sup>2</sup>



### Uso profissional

- Professional use  
- Uso profesional  
- Usage professionnel

## Translation | Traducción | Traduction

ALUMINIUM TOWER 2000X700 ALUMAX - Use: Intensive, Use: Level Floor, Warranty: 5 Years, Standard: EN1004-1/2004, With safety guards, Boards with interior access hatch, With removable 150mm skirting boards, 125mm directional wheels with brakes, Profiles with quick-release hooks, Welded aluminum frame with Ø 50x2 mm tube, Stabilizer bars with Ø 46.5x3 mm tube, Reinforced with internal connection with Ø 45x2 mm tube

TORRE DE ALUMINIO 2000X700 ALUMAX - Uso: Intensivo, Uso: Suelo plano, Garantía: 5 años, Norma: EN1004-1/2004, Con protecciones de seguridad, Paneles con trampilla de acceso interior, Con rodapiés extraíbles de 150 mm, Ruedas direccionales de 125 mm con freno, Perfiles con ganchos de liberación rápida, Marco de aluminio soldado con tubo de Ø 50 x 2 mm, Barras estabilizadoras con tubo de Ø 46,5 x 3 mm, Reforzado con conexión interna con tubo de Ø 45 x 2 mm

ECHAUFDAUGE EN ALUMINIUM 2000X700 ALUMAX - Usage: Intensif, Usage: Sol plat, Garantie: 5 ans, Norme: EN1004-1/2004, Avec protections de sécurité, Panneaux avec trappe d'accès intérieure, Avec plinthes amovibles de 150 mm, Roues directionnelles de 125 mm avec freins, Profils avec crochets à démontage rapide, Châssis en aluminium soudé avec tube Ø 50 x 2 mm, Barres stabilisatrices avec tube Ø 46,5 x 3 mm, Renforcé avec connexion interne avec tube Ø 45 x 2 mm



EN-1004-1:2021



## DIVERSOS

- Cavalete
- Régua pedreiro e estucador
- Acessórios
- Kit's
- Estantes Metálicas

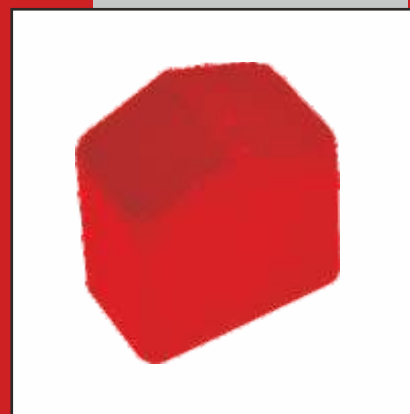

# CAVALETE EM ALUMÍNIO

ALUMINIUM EASEL | CABALLETE DE ALUMINIO |  
CHEVALET EN ALUMINIUM

## Características

- Capacidade admissível de 150 kgs com base apoio de 16 cm.
- Perfis de reforço soldados em cada lado
- Dobradiças de aço
- Tacos de Nylon anti derrapantes
- Anti fecho de segurança em aço
- 150 Kgs Carga admissível
- Peso 4,5kgs
- Perfis de apoio – 66x25mm
- Base superior de apoio – 73x25mm

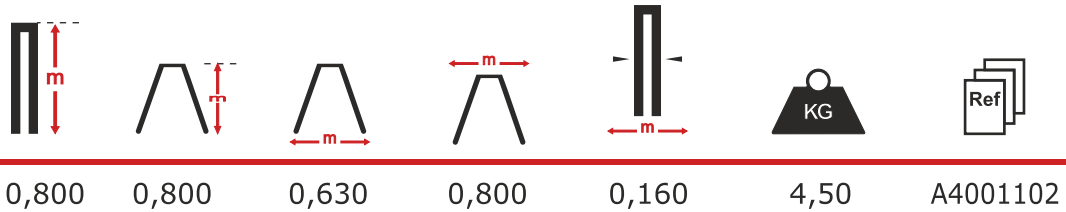
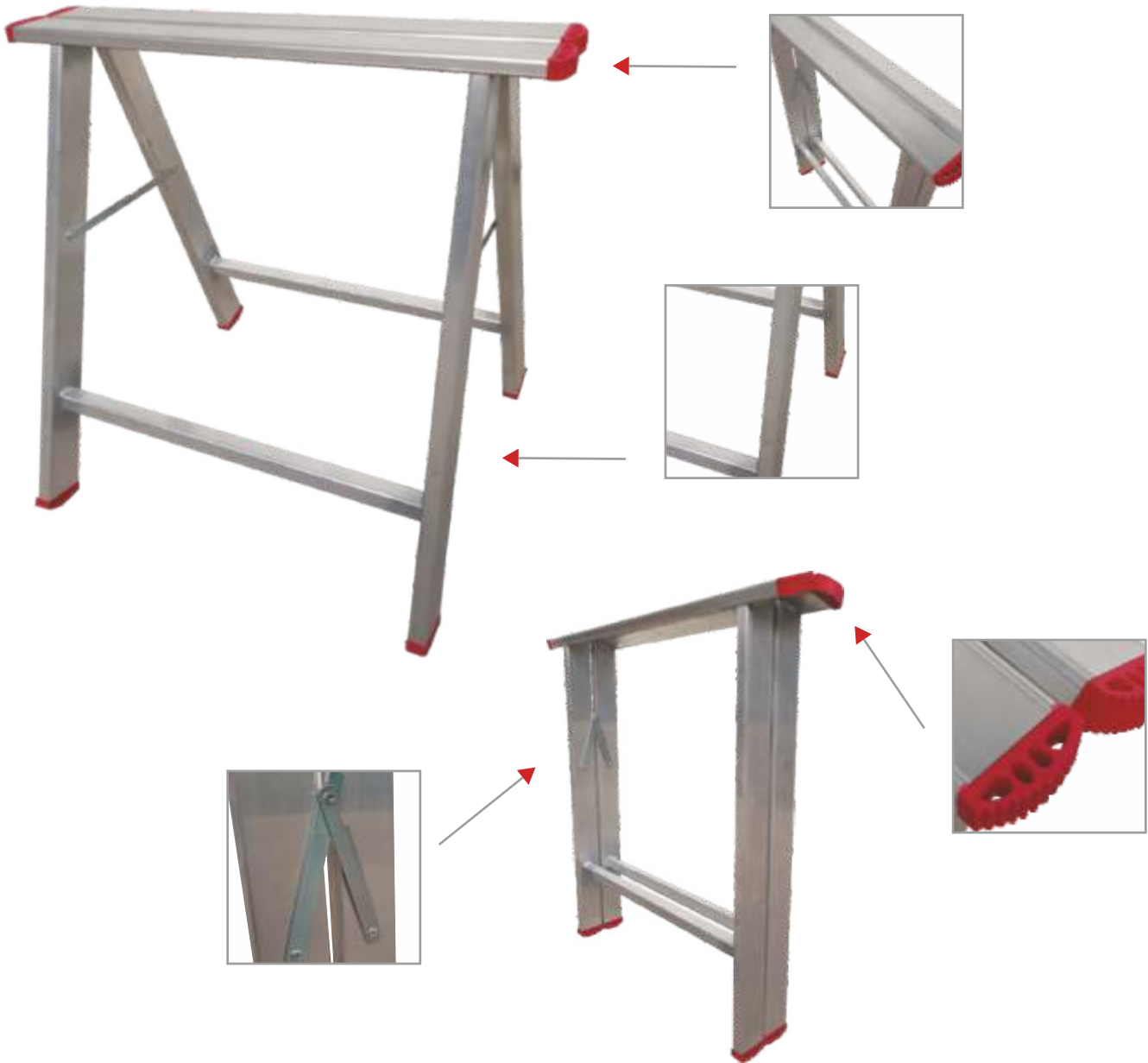

## Translation | Traducción | La traduction

- Aluminum easel - Allowable capacity of 150kgs with support base of 16 cm. - Welded reinforcement profiles on each side - Steel hinges - Non-slip Nylon Pads - Anti-lock steel security - 150Kgs Permissible Load - Weight 4.5 kgs - Support profiles - 66x25mm - Uppers support base - 73x25mm.
- Caballete de aluminio - Capacidad admisible de 150 kg con base de apoyo de 16 cm. - Perfiles de refuerzo soldados en cada lado - Bisagras de acero - Almohadillas de nailon antideslizantes - Seguridad de acero antibloqueo - 150 kg de carga permitida - Peso 4,5kgs - Perfiles de soporte: 66x25 mm - Base de soporte superior: 73x25mm.
- Tréteaux en Aluminium - Capacité admissible de 150kgs avec base de support de 16 cm. - Profils de renfort soudés de chaque côté - Charnières en acier - Coussinets en nylon antidérapants - Sécurité en acier anti-blocage - 150 kg de charge admissible - Poids 4,5 kg - Profils de support - 66x25mm - Base supérieure de support - 73x25mm.



# RÉGUAS EM ALUMÍNIO

Aluminum rulers | Reglas de aluminio | Règles en aluminium

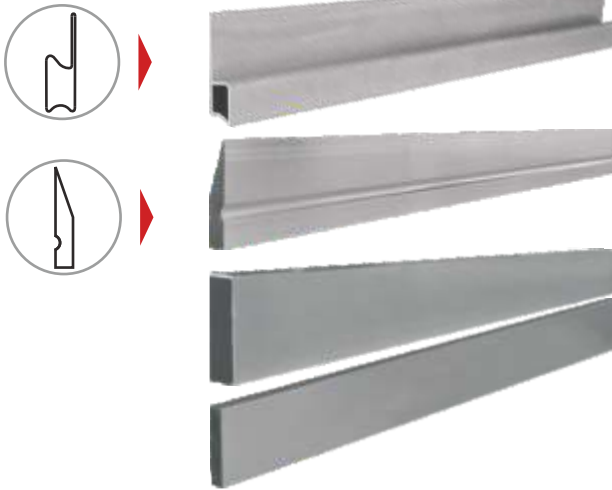

## ESTUCADOR H FECHADO

PLASTERER H CLOSED / YESERO H CERRADO / PLÂTRIER H FERMÉ

## ESTUCADOR BISELADO

PLASTERER BEVELLED/ YESERO BISELADO / PLÂTRIER BISEAUTÉ

## PEDREIRO 120X20 C/ REFORÇO

MASON 120X20 WITH REINFORCEMENT / ALBAÑIL 120X20 C/ REFUERZO  
MAÇON 120X20 AVEC RENFORT

## PEDREIRO 70X20

MASON 70X20 / ALBAÑIL 70X20  
MAÇON 70X20

Vendido ao metro / Outros modelos sob consulta

Sold per meter / Other models under request

Vendido al metro / Otros modelos bajo petición

Vendu au mètre / Autres modèles sur demande

# PLATAFORMA DEGRAU ESCADA

Stair-step platform | Plataforma escalonada | Plateforme en escalier



# ACESSÓRIOS

Accessories | Accesorios | Accessoires

## BASES ESTABILIZADORAS

Stabilising Base / Base estabilizadora / Base de Stabilisation



## TOPOS DE DEGRAU

Steps Tops / Topes de Peldaño / Haut de Marche



◀ Topos de degrau 50  
Step Tops 50  
Topes de Peldaño 50  
Hauts de Marche 50



◀ Topos de degrau 40  
Step Tops 40  
Topes de Peldaño 40  
Hauts de Marche 40



◀ Topos de degrau Multiposições  
Step Tops Multi-Position  
Topes de Peldaño Multiposiciones  
Hauts de Multi-Positions



◀ Topos de degrau Potente  
Step Tops Potente  
Topes de Peldaño Potente  
Hauts de Marche Potente

## TACOS ANTIDERRAPANTES

Slip-Resistant Feet / Tacos Antideslizantes / Sabots Antidérapants



◀ Taco de Embutir 50X20 - 40X20 - 33X20  
Plug-in Foot 50X20 - 40X20 - 33X20  
Taco Plug-in 50X20 - 40X20 - 33X20  
Sabot Plug-in 50X20 - 40X20 - 33X20



◀ Taco de Embutir 60  
Plug-in Foot 60  
Taco Plug-in 60  
Sabot Plug-in 60



◀ Taco de Base  
Base Foot  
Taco de Base  
Sabot de Base



◀ Taco de Escada 66 + 80  
Ladder Foot 66 + 80  
Taco de Escalera 66 + 80  
Sabot d'Échelle 66 + 80

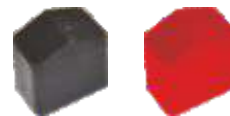

◀ Taco 33X20  
Foot 33X20  
Taco 33X20  
Sabot 33X20



◀ Taco 50X20  
Foot 50X20  
Taco 50X20  
Sabot 50X20



◀ Taco 73  
Foot 73  
Taco 73  
Sabot 73



# ESTANTES METÁLICAS

Metal shelving | Estanterías metálicas | Étagères en métal

Grades Convencionais | Palletising Shelving  
Estanterías de Paletización | Rayonnages pour Palettisation



Estantes Dinâmicas | Dynamic Shelving  
Estanterías Dinámicas | Étagères Dynamiques



Estantes Drive-in | Drive-in Shelving  
Estanterías Drive-in | Rayonnages Drive-in



Plataformas Sigma | Sigma Platforms  
Plataformas Sigma | Plateformes Sigma



# ESTANTES METÁLICAS

Metal shelving | Estanterías metálicas | Étagères en métal

*Estantes Picking U55 | Picking U55 Shelving  
Estanterías Picking U55 | Rayonnages Picking U55*



*Estantes Picking LT50 | Picking LT50 Shelving  
Estanterías Picking LT50 | Rayonnages Picking LT50*



*Estantes Archivo | Archive Shelving  
Estanterías Archivo | Rayonnages Archive*



*Estantes Cantilever | Cantilever Shelving  
Estanterías Cantilever | Rayonnages Cantilever*



# SUGESTÕES DE DECORAÇÃO COM ESTANTES METÁLICAS

IDEAL para a sua Garagem, Escritório, Despensa de Cozinha, Entrada de Casa, Sala de Estar, Oficina, Trabalho, Lavandaria, Etc.



Apresentamos aqui algumas das nossas soluções para otimização do espaço de armazenagem através dos nossos KITS de montagem fácil, seguindo a filosofia, "leve e faça você mesmo". Os nossos KITS são especialmente indicados para quem pretende armazenar cargas médias com uma elevada relação preço/qualidade.

Here we present some of our solutions for optimising storage space using our easy-to-assemble KITS following the philosophy of being "light and do-it-yourself". Our KITS are especially suitable for clients who want to store medium loads with an elevated price-quality ratio.

Presentamos a continuación algunas de nuestras soluciones para optimización del espacio de almacenaje mediante nuestros KITS de montaje fácil, siguiendo la filosofía, "llevélo y hágalo usted mismo". Nuestros KITS están especialmente indicados para quienes pretenden almacenar cargas medias con elevada relación precio/calidad.

Nous vous présentons ici quelques unes de nos solutions pour optimiser l'espace de stockage grâce à nos KITS faciles à assembler, en suivant la philosophie «prenez et faites-le vous-même». Nos KITS sont particulièrement adaptés à ceux qui souhaitent stocker des charges moyennes avec un excellent rapport qualité/prix.

# DIY Estantes Metálicas Utilitárias para Bricolage

OFERECEMOS UMA VASTA GAMA DE SOLUÇÕES VERSÁTEIS PARA DIFERENTES USOS!





Kit de montagem rápido, indicado para armazenamento de cargas leves, elevada otimização do espaço de armazenamento. Varietas disponíveis: montagem com parafusos / montagem de encaixe / prateleiras em aglomerado.  
Kits Shelves - Fast and easy assembly kits, indicated for light load storage, high storage space optimisation. Available varieties: assembly with screws / assembly with joints / chipboard shelves.  
Estantes en Kit - Kits de montaje fácil y rápida, adecuados para el almacenamiento de carga ligera, alta optimización del espacio de almacenamiento.  
Varietades disponibles: montaje con tornillos / montaje de encajar / anaqueles en aglomerado.  
Étagères en Kit - Kits faciles et rapides à assembler, indiqués pour le stockage de charges légères, haute optimisation de l'espace de stockage. Variétés disponibles: assemblage avec vis / assemblage à raccord / étagères en aggloméré.



**Litan**



 Rua Principal, N° 635 | Zona Industrial da Giesteira | 3750-325 Águeda | PORTUGAL

 N: 40.580 42° - W: 8.412 16°

 T. +351 234 623 490

 [geral@litan.pt](mailto:geral@litan.pt)

 [www.litan.pt](http://www.litan.pt)